

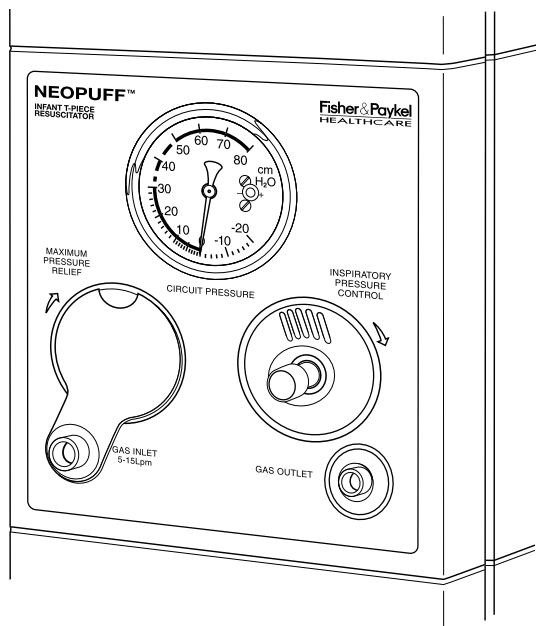

TABLE OF CONTENTS

The Fisher & Paykel Healthcare CosyCot has been discontinued. This product catalogue contains Infant Warmer Accessories that are still available to support existing customers.

Neopuff™ Infant T-Piece Resuscitator	3
Thermal Management and General Accessories.....	4-5
Gas Hose Accessories.....	6-7

NEOPUFF INFANT T-PIECE RESUSCITATOR



Integrated Neopuff Module

Neopuff Infant T-Piece Resuscitator IW Module

The Neopuff Infant Resuscitator is available as an integrated module inserted into the front of the CosyCot Infant Warmer.

An added feature to the CosyCot Infant Warmer, this allows easy access for the operator in resuscitating the patient, especially during transport.

Product Code	Description
900IW130E	Neopuff Infant T-Piece Resuscitator IW Module - ENGLISH
900IW130F	Neopuff Infant T-Piece Resuscitator IW Module - FRENCH
900IW130G	Perivent Infant T-Piece Resuscitator IW Module - GERMAN
900IW130L	Neopuff Infant T-Piece Resuscitator IW Module - ITALIAN
900IW130N	Neopuff Infant T-Piece Resuscitator IW Module - DUTCH
900IW130S	Neopuff Infant T-Piece Resuscitator IW Module - SPANISH
900IW130V	Neopuff Infant T-Piece Resuscitator IW Module - NORWEGIAN
900IW130Z	Neopuff Infant T-Piece Resuscitator IW Module - CHINESE

Thermal Management & General Accessories

DuoSense Reusable Skin Sensor

The DuoSense Skin Sensor utilises two independent thermistors that are continuously compared to ensure accuracy and reliability in temperature control.

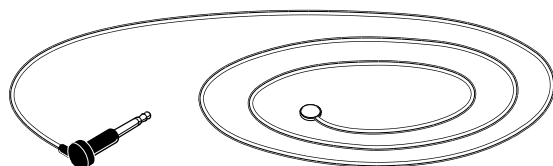

- **Length 1.6m (63")**
- **Reusable**
- **Included with Baby Controlled Warmers (IW910, IW931, IW932, IW933, IW934 and IW980)**

Product Code	Description
900IW001	DuoSense Skin Sensor

SureSense Single Use Temperature Sensor

The SureSense is a single patient use temperature sensor designed for temperature measurement with a thermistor accuracy of +/- 0.1°C accuracy.

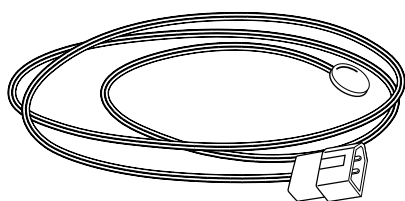

SureSense

- **Use with Reusable Adaptor 900IW003**

Product Code	Description
NC020-20	SureSense Single Use Temperature Sensor (20 pack)
NC021-20	SureSense Single Use Temperature Sensor (20 pack) US

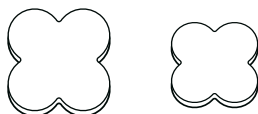

DaisyDot and DaisyDot mini Sensor Covers

The DaisyDot covers are single baby multi use items, with reflective and insulative properties to protect the skin sensor from external sources of heat.

Product Code	Description
NC040-10	DaisyDot Sensor Cover (10 pack)
NC041-10	DaisyDot mini Sensor Cover (10 pack)

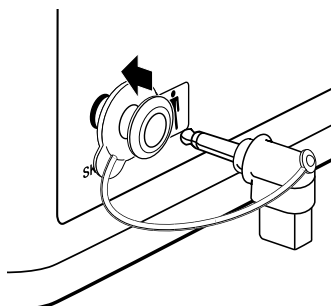

Reusable adaptor for SureSense temperature Sensor

The Reusable adaptor for the single use temperature sensor, SureSense, is designed with a leash to prevent the adaptor from becoming dislodged from the Fisher & Paykel Healthcare infant warmers.

Product Code	Description
900IW003	Reusable adaptor for SureSense sensor

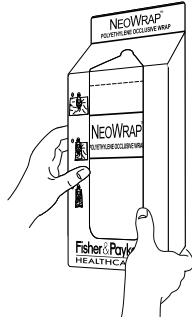
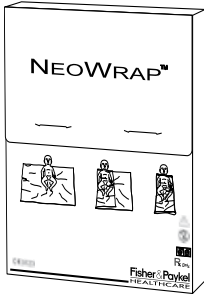

NeoWrap Occlusive Wrap

The NeoWrap occlusive wrap is a single patient use, transparent polyethylene wrap designed to reduce postnatal temperature decline and evaporative heat loss.

Product Code	Description
NC100-SK	NeoWrap Starter Kit
NC100-10	NeoWrap (box of 10)
NC100-25	NeoWrap (dispensing box of 25)

Mattress

The Mattress is specially designed to reduce heat loss by way of conduction and can be purchased separately. The Mattress is available in two sizes to fit to the appropriate bassinet.

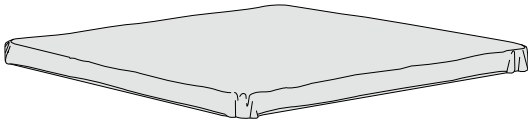

Product Code	Description
900IW201	Mattress - Standard 60 x 60cm
900IW213	Mattress - Long 60 x 70cm

Bacteria Filter

A standard Millipore brand filter for the Venturi Suction Unit.

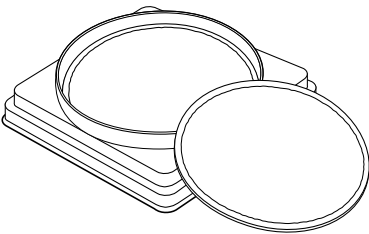

Product Code	Description
043042144	Bacteria Filter Available in packs of 25.

GAS HOSE ACCESSORIES



Gas Hose Accessories

Fisher & Paykel Healthcare offer the following range of gas hoses for our Gas Accessories. If your exact requirements are not met within this range, please discuss your requirements with your Fisher & Paykel Healthcare representative.

- 3 meter (10') Hoses**

From	To
Gas Accessory Block	Hospital Pipeline Supply
Gas Low Pressure Module	Hospital Pipeline Supply
Gas Supply Module	Hospital Pipeline Supply
- 550 mm (2') Hoses**

From	To
Gas Accessory Block	Gas Supply Module
Gas Accessory Block	Cylinder Regulator
Gas Low Pressure Module	Cylinder Regulator

OXYGEN				
Manifold Hose Fitting	Wall/Cylinder Hose Fitting	Hose Length	Hose Colour	Part Number
DISS	DISS	550mm (2')	Green	HS-02UO-DHDFC4
DISS	DISS	3m (10')	Green	HS-10UO-DHDFC4
DISS	OHMEDA	3m (10')	Green	HS-10UO-DFOMC4
DISS	PURITAN	3m (10')	Green	HS-10UO-DFPMC4
DISS	CHEMETRON	3m (10')	Green	HS-10UO-DFCMC4
DISS	SCHRADER	3m (10')	Green	HS-10UO-DFBMC4
DISS	DISS	550mm (2')	White	HS-02IO-DHDFC4
DISS	DISS	3m (10')	White	HS-10IO-DHDFC4
NIST	BS PROBE	3m (10')	White	HS-10IO-NFBMC4
NIST	BS PROBE	550mm (2')	White	HS-02IO-NFBMC4
DISS	BS PROBE	3m (10')	White	HS-10IO-DFBMC4

AIR				
Manifold Hose Fitting	Wall/Cylinder Hose Fitting	Hose Length	Hose Colour	Part Number
DISS	DISS	550mm (2')	Yellow	HS-02UA-DHDFC4
DISS	DISS	3m (10')	Yellow	HS-10UA-DHDFC4
DISS	OHMEDA	3m (10')	Yellow	HS-10UA-DFOMC4
DISS	PURITAN	3m (10')	Yellow	HS-10UA-DFPMC4
DISS	CHEMETRON	3m (10')	Yellow	HS-10UA-DFCMC4
DISS	SCHRADER	3m (10')	Yellow	HS-10UA-DFSMC4
DISS	DISS	550mm (2')	Black	HS-02IA-DHDFC4
DISS	DISS	3m (10')	Black	HS-10IA-DHDFC4
NIST	BS PROBE	3m (10')	Black	HS-10IA-NFBMC4
NIST	BS PROBE	550mm (2')	Black	HS-02IA-NFBMC4
DISS	BS PROBE	3m (10')	Black	HS-10-IA-DFBMC4

VACUUM

LH Hose Fitting	RH Hose Fitting	Hose Length	Hose Colour	Part Number
DISS	DISS	3m (10')	White	HS-10UV-DHDFC5
NIST	BS PROBE	3m (10')	Yellow	HS-10IV-NFBMC4

Color Code:

- U** : USA
- I** : ISO

Length in feet

HS - **XYZ** - **XYXX**

Hose Type:

- C4** : Conductive 1/4"
- C5** : Conductive 5/16"

Gas Type:

- O** : Oxygen
- A** : Medical Air
- V** : Medical Vacuum

Inlet & Outlet Connections:

- DF** : DISS Hex Nut
- DH** : DISS Handtight
- NF** : NIST Hex Nut
- BM** : BS PROBE Male
- OM** : Ohmeda Male
- PM** : Puritan Male
- CM** : Chemetron Male
- SM** : Schrader Male

For more information please contact your local Fisher & Paykel Healthcare representative

Manufacturer

Fisher & Paykel Healthcare Ltd,
15 Maurice Paykel Place,
East Tamaki, Auckland 2013
PO Box 14 348 Panmure,
Auckland 1741,
New Zealand

Tel: +64 9 574 0100
Fax: +64 9 574 0158
Email: info@fphcare.co.nz
Web: www.fphcare.com

Importer/ Distributor
Australia (Sponsor)
Fisher & Paykel Healthcare Pty Ltd,
19-31 King Street, Nunawading,
Melbourne, Victoria 3131.

Tel: +61 3 9871 4900
Fax: +61 3 9871 4998

Austria

Tel: 0800 29 31 23
Fax: 0800 29 31 22

Benelux

Tel: +31 40 216 3555
Fax: +31 40 216 3554

Brazil

Fisher & Paykel do Brasil,
Rua Sampaio Viana, 277 cj 21,
Paraíso, 04004-000,
São Paulo - SP, Brazil
Tel: +55 11 2548 7002

China

代理人/售后服务机构:
费雪派克医疗保健(广州)有限公司, 广州高新技术
产业开发区科学城科丰路31号G12栋301号

电话: +86 20 32053486
传真: +86 20 32052132

Denmark

Tel: +45 70 26 37 70
Fax: +46 83 66 310

Finland

Tel: +358 9 251 66 123
Fax: +46 83 66 310

France

Fisher & Paykel Healthcare SAS, 10 Av. du Québec,
Bât F5, BP 512, Villebon-sur-Yvette, 91946
Courtaboeuf Cedex, France

Tel: +33 1 6446 5201
Fax: +33 1 6446 5221
Email: c.s@fphcare.fr

Germany

Fisher & Paykel Healthcare GmbH, Deutschland,
Österreich, Schweiz, Wiesenstrasse 49,
D 73614 Schorndorf, Germany

Tel: +49 7181 98599 0
Fax: +49 7181 98599 66

Hong Kong

Tel: +852 2116 0032
Fax: +852 2116 0085

India

Tel: +91 80 2309 6400

Ireland

Tel: 1800 409 011
Fax: +44 1628 626 146

Italy

Tel: +39 06 7839 2939
Fax: +39 06 7814 7709

Japan

Tel: +81 3 5117 7110
Fax: +81 3 5117 7115

Korea

Tel: +82 2 6205 6900
Fax: +82 2 6309 6901

Mexico

Tel: +52 55 9130 1626

Norway

Tel: +47 21 60 13 53
Fax: +47 22 99 60 10

Poland

Tel: 00800 49 119 77
Fax: 00800 49 119 78

Russia

Tel. and Fax: +7 495 782 21 50

Spain

Tel: +34 902 013 346
Fax: +34 902 013 379

Sweden

Tel: +46 8 564 76 680
Fax: +46 8 36 63 10

Switzerland

Tel: 0800 83 47 63
Fax: 0800 83 47 54

Taiwan

Tel: +886 2 8751 1739
Fax: +886 2 8751 5625

Turkey

İthalatçı Firma: Fisher Paykel Sağlık Ürünleri Ticaret
Limited Şirketi,

İletişim Bilgileri: Ostim Mahallesi 1249,
Cadde No:6, Yenimahalle, Ankara, Türkiye 06374,

Tel: +90 312 354 34 12
Fax: +90 312 354 31 01

UK

Fisher & Paykel Healthcare Ltd,
Unit 16, Cordwallis Park, Clivemont Road,
Maidenhead, Berkshire SL6 7BU, UK

Tel: 0800 132 189
Fax: +44 1628 626 146

USA/Canada

Tel: 1800 446 3908
or +1 949 453 4000
Fax: +1 949 453 4001