

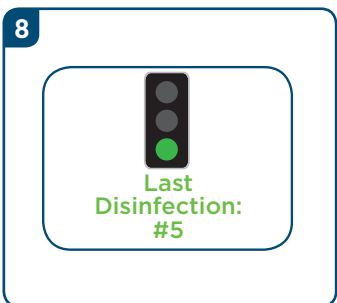

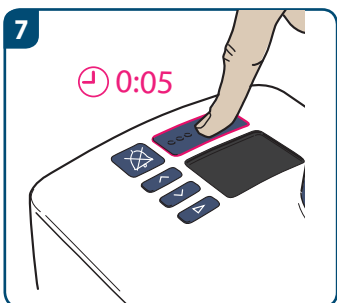

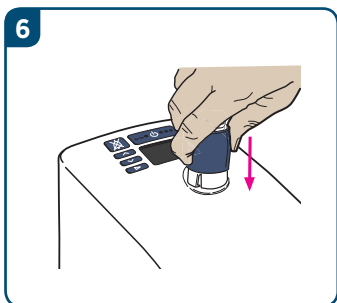

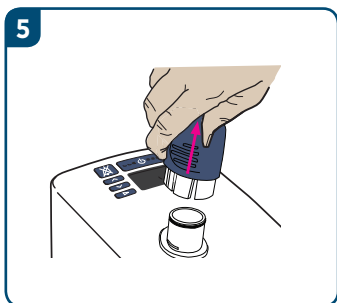

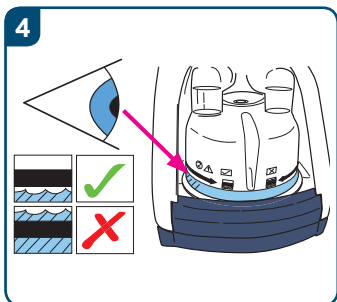
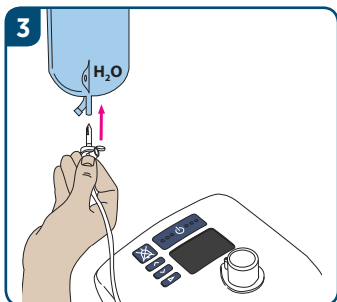
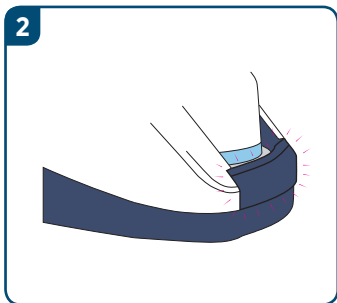
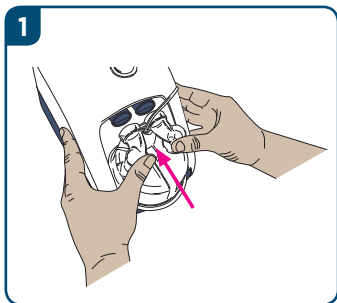



# F&P AIRVO 2



# F&P AIRVO 2

Patient Interface	°C			L/min												
	31	34	37	2	5	10	15	20	25	...	...	50	55	60		
 OPT316/OJR416	●			2		20										
 OPT318/OJR418	●			2		25										
 OPT942 (S)	●	●	●			10		50								
 OPT944 (M)	●	●	●			10									60	
 OPT946 (L)	●	●	●			10									60	
 OPT970	●	●	●			10									60	
 OPT980	●	●	●			10									60	
 OPT842 (S)	●	●	●			10		50								
 OPT844 (M)	●	●	●			10									60	
 OPT846 (L)	●	●	●			10									60	
 OPT870	●	●	●			10									60	
 RT013	●	●	●			10									60	

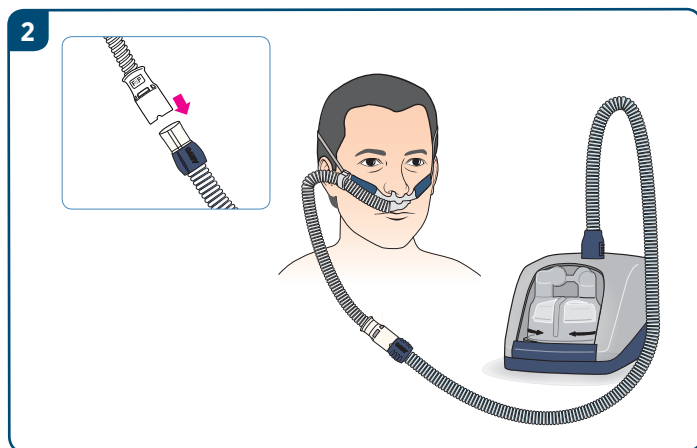
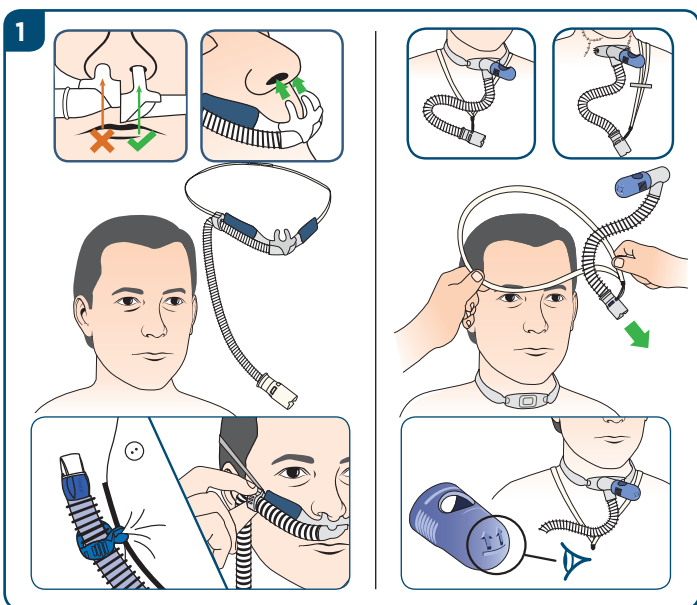



# F&P AIRVO 2

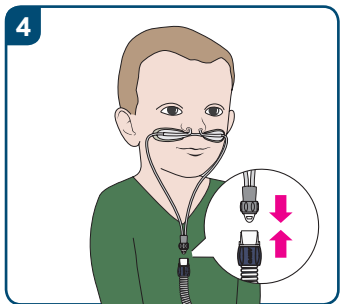
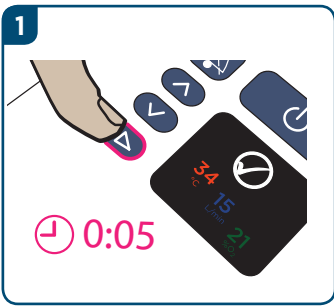
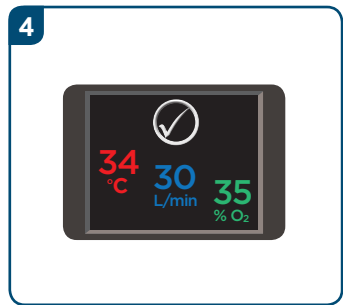

# F&P AIRVO 2

