

USER MANUAL





Intellectual property information

Fisher & Paykel Healthcare products:

F&P, Airvo, AirSpiral, Optiflow, WigglewiNG and Wigglepads are trademarks of Fisher & Paykel Healthcare Limited.

For patent information refer to: www.fphcare.com/ip

For more information, please contact your local Fisher & Paykel Healthcare representative.

Compatible third-party products:

Nonin:

Nonin™, Xpod®, PureLight®, PureSAT®, FlexiWraps®, Flexi-Form® are trademarks of Nonin Medical Inc.

For patent information refer to: www.nonin.com

Using any sensors other than Nonin-branded PureLight® sensors with the Nonin Xpod USB connector may result in inaccurate performance (of the Airvo 3 and/or Nonin products) and will void the Nonin product warranty.

Before you start

- This user manual is for instructions on using the Airvo™ 3 model, hereafter referred to as “Airvo 3”.
- This user manual is intended for healthcare professionals. While the information provided is believed to be accurate, it is not a substitute for exercising professional judgement.
- Read this user manual, including all warnings, before using the Airvo 3.
- Before the Airvo 3 is used for the first time, it must be set up according to the instructions in the Airvo 3 Technical Manual.
- Some accessories may not be available in certain countries. Please contact your local Fisher & Paykel Healthcare representative for more information.
- If any device or accessory label is damaged or unreadable, contact your Fisher & Paykel Healthcare representative for a replacement.

Additional resources

- If using the Disinfection Kit to reprocess the Airvo 3, refer to the Disinfection Kit Manual provided with the Disinfection Kit (900PT600).
- Refer to user instructions supplied with individual accessories for correct use and additional safety information.
- Refer to the Airvo 3 Technical Manual for initial setup, maintenance, servicing and additional troubleshooting instructions.
- Visit the Airvo 3 website at: www.fphcare.com/airvo3 to download user instructions including this user manual.
- For assistance from your Fisher & Paykel Healthcare representative contact us at: www.fphcare.com/contact-us.

Conventions used in this manual

Warning

A warning alerts the user to a potential hazard with use or misuse of the device which, if not avoided, could result in death or serious injury.

Caution

A caution alerts the user to a potential hazard with use or misuse of the device which, if not avoided, could result in minor or moderate injury.

Note

A note emphasizes information important for using the Airvo 3 correctly.

Contents

Before you start	1
1 Introduction	4
1.1 Intended/indications for use	4
1.2 Contraindications	4
1.3 Side-effects	4
2 Safety information	4
2.1 General	4
2.2 Supplementary oxygen	6
2.3 Pulse oximetry	6
3 Overview	7
3.1 Identifying system components	7
3.2 Identifying device components	8
3.3 Navigating the user interface	9
4 Preparing the Airvo 3	11
4.1 Equipment required	11
4.2 Airvo 3 setup	13
4.3 Supplementary oxygen	15
4.4 Additional set up for pulse oximetry	16
5 Using the Airvo 3	17
5.1 Getting started	17
5.2 Optiflow high flow therapy settings	18
5.3 Starting Optiflow high flow	19
5.4 During therapy	22
5.5 Mobility and battery operation	26
5.6 Stopping therapy	27
6 Monitoring data	28
6.1 Patient data	28

6.2	Live value graphs	29
6.3	Long term graphs	29
7	Troubleshooting	30
7.1	Alarms	30
7.2	Alarm priority	30
7.3	Auditory information signals	30
7.4	Viewing alarm details	31
7.5	Checking the alarm system	31
7.6	Airvo 3 alarms	31
7.7	Pulse oximetry	36
8	Reprocessing	37
8.1	Airvo 3 device exterior reprocessing	37
8.2	Outlet elbow reprocessing	38
8.3	Schedule for changing accessories	40
8.4	Replacing the air-filter	40
8.5	Servicing	41
9	Pulse oximetry	41
9.1	Description of measurements	41
9.2	Description of settings and alarms	42
9.3	Alarm and measurement settings	43
	Specifications	45
	Glossary	49
	Appendix 1. Patient consumables	50
	Appendix 2. Parts and accessories	51
	Appendix 3. Pulse oximetry accessories	52
	Appendix 4. Humidification behavior during battery operation	53

1. Introduction

The Airvo 3 is designed to deliver Optiflow™ high flow therapy to spontaneously breathing patients.

A blower inside the Airvo 3 entrains flows of room air of 2 - 70 L/min, which may be blended with oxygen from high-pressure sources (such as wall supplies or bottles) or low-pressure sources (such as flowmeters). The air-oxygen mixture is then warmed and humidified in the water chamber, before being transported through the heated breathing tube to a nasal, tracheostomy or mask patient interface. The Airvo 3 is powered by AC, with internal battery backup to provide continuity of therapy during intra-hospital transport.

1.1 Intended use/indications for use

The Airvo 3 is for the treatment of spontaneously breathing patients who would benefit from receiving high flow warmed and humidified respiratory gases. This includes patients who have had upper airways bypassed. The flow may be from 2 - 70 L/min depending on the patient interface. The Airvo 3 is for patients in hospitals and sub-acute facilities.

The Airvo 3 can deliver these high flow gases through nasal cannula to augment the breathing of spontaneously breathing neonate, infant, child, adolescent and adult patients suffering from respiratory distress and/or hypoxemia in the hospital setting. The Airvo 3 is not intended to provide total ventilatory requirements of the patient and is not for use during field transport.

1.2 Contraindications

Contraindications are therapy-specific. Refer to instructions of patient interfaces and/or tube and chamber kits for therapy-specific contraindications.

1.3 Side-effects

Side-effects are therapy-specific. Refer to instructions of patient interfaces and/or tube and chamber kits for therapy-specific side-effects.

2. Safety information

The Airvo 3 and accessories are to be operated by, or under the supervision of, qualified personnel only. Read this manual and the instructions for use supplied with all accessories (particularly all warnings, cautions and notes) before using the device.

2.1 General

Warnings

- The Airvo 3 is not intended for life support. Do not use Airvo 3 on patients who cannot tolerate a brief interruption of therapy.
- Appropriate patient monitoring is required for all patients using the Airvo 3.
- Delivery of respiratory gases may generate positive airway pressure. This must be considered where positive airway pressure could have adverse effects on a patient. To avoid serious injury, appropriately monitor the patient for risk factors of airway and lung pressure injury.
- Anybody connecting patient consumables, accessories or spare parts to the Airvo 3 is accountable for the compatibility of the device and those patient consumables, accessories and/or spare parts.
- Do not use any patient consumables, accessories or spare parts that are not listed in this user manual, or the Airvo 3 Technical Manual. Incompatible consumables, parts or accessories could affect the quality of therapy, injure the patient, decrease electromagnetic immunity or increase electromagnetic emissions.
- Use only patient interfaces, heated breathing tubes, water chambers and filters specified in this manual to prevent disconnection during use, especially when moving the Airvo 3.
- Do not use antistatic or electrically conductive hoses or tubing with the Airvo 3.
- Do not connect the Airvo 3 to the battery of a battery-powered wheelchair, which may compromise device performance and therapy delivered.
- Carefully route accessories, cords and cables, including the breathing tube, to reduce the possibility of patient entanglement or strangulation.
- Visually inspect the Airvo 3 and accessories before use and replace if damaged or suspected to be damaged. Using a damaged device or accessories may impair performance and/or compromise safety.
- Make sure the auditory alarm signal is audible to the operator who will respond to alarms by following the instructions in section 7.5 to test the alarm before starting therapy.
- Do not use an Airvo 3 on more than one patient at any one time.
- Do not use accessories beyond the maximum period of use specified in this manual. Exceeding the maximum use period can result in serious injury, including infection.

- Do not expose the Airvo 3 battery to water, fire or excessive heat. Do not crush, disassemble or puncture the battery, or short-circuit the connector terminals.
- In the event of a battery leaking, do not allow the liquid to come in contact with the skin or eyes. If contact has been made, wash the affected area with copious amounts of water and seek medical advice.
- Seek medical advice immediately if a cell or a battery has been swallowed.
- Changes or modifications not expressly approved by Fisher & Paykel Healthcare voids the user's authority to operate the device.
- Do not use any solutions, suspensions, emulsions, anesthetic or respirable gases that are not identified in these user instructions. They may not be compatible with the patient consumables, device or accessories.
- Use only genuine F&P replacement battery modules to prevent damage to the Airvo 3, excess temperature, fire or explosion.

Operating environment

- Do not use the Airvo 3 above the altitude range listed in the specifications section of the manual.
- Do not use the Airvo 3 when outside the operating conditions listed in the specifications section. Therapy may be compromised outside this range.
- Do not use the Airvo 3 in a magnetic resonance imaging (MRI) environment.
- Do not use the Airvo 3 with, or in the presence of, a flammable anesthetic mixture with air or oxygen.
- Do not use the Airvo 3, or accessories, during defibrillation.
- Do not use the Airvo 3, or accessories, near any ignition source, including electrosurgery, electrocautery or laser surgery instruments. Exposure to oxygen increases the risk of fire that may result in patient injury.
- Do not use the Airvo 3 in a hyperbaric chamber.
- Avoid using the Airvo 3, or accessories, adjacent to, or stacked with, other equipment, which could result in improper operation. If such use is necessary, this equipment and the other equipment should be observed to verify that they are operating normally.
- The Airvo 3 is not designed for use in the home. Contact your Fisher & Paykel Healthcare representative for information about the myAirvo™ 3.

Caution

- The emissions characteristics of this equipment make it suitable for use in industrial areas and hospitals (CISPR 11 class A). If it is used in a residential environment (for which CISPR 11 class B is normally required) this equipment might not offer adequate protection to radio-frequency communication services. The user might need to take mitigation measures, such as relocating or re-orienting the equipment.

To avoid burns

- Do not touch the hot surface of the heater-plate or chamber base.
- Never operate the Airvo 3 if:
 - the heated breathing tube has been damaged in any way including holes, tears or kinks,
 - it is not working properly, or
 - water has entered the device.
- Do not restrict ventilation around the Airvo 3, which may cause it to overheat.
- Do not block the flow of air through the Airvo 3 or breathing tube.

To avoid electric shock

- Do not store or use the Airvo 3 where it can fall, or be pulled, into water. Disconnect the power cord and stop using the Airvo 3 if water has entered the case.
- Never operate the Airvo 3 if it has, or is suspected of having:
 - been dropped or damaged,
 - a damaged power cord or plug, or
 - been dropped into water.
- See the Airvo 3 Technical Manual for instructions to replace a damaged power cord.
- Do not attempt to adjust, repair, open, disassemble or modify the Airvo 3 except as described in this user manual or the Airvo 3 Technical Manual. Return the Airvo 3 to your Fisher & Paykel Healthcare representative for servicing, if necessary.
- Do not touch the patient at the same time as any conductive parts of the device, such as USB ports.

Notes

- If a serious incident has occurred while using this device please inform your local Fisher & Paykel Healthcare representative and Competent Authority in your country.

2.2 Supplementary oxygen

Warnings

- You must take special care when using supplementary oxygen to reduce the risk of fire. Keep all sources of ignition away from the Airvo 3 and, preferably, not in the same room as the Airvo 3 during use.
- Do not use supplementary oxygen while smoking, near sparks or open flames.
- A spontaneous and violent ignition may occur if oil, grease or greasy substances contact oxygen under pressure. Keep these substances away from all oxygen equipment.
- The Airvo 3 is a high flow device. Ensure the oxygen supply is designed to provide enough oxygen flow for all connected equipment, particularly when the supply is shared by multiple devices.
- Only connect pure oxygen to the oxygen inlet ports on the Airvo 3. The oxygen concentration displayed will be wrong if any other gas, or mixtures of gases, is connected.
- Only use lotions and/or salves that are labeled as oxygen-compatible to avoid the risk of fire and burns.

2.3 Pulse oximetry

Warnings

- Do not adjust, repair, open, disassemble, or modify the pulse oximetry sensor, cable or adapter (pulse oximetry accessories). Injury to personnel or equipment damage could occur. Return the device for servicing if necessary.
- The Airvo 3 does not replace a vital signs monitor. A separate and dedicated monitoring device must be used if such monitoring is required.
- Explosive hazard: Do not use this device in an explosive atmosphere or in the presence of flammable anesthetics or gases.

Nonin:

- Operation of the Nonin Xpod USB connector below the minimum amplitude of 0.3% modulation may cause inaccurate results.

Cautions

- Before cleaning the pulse oximetry accessories, disconnect the device from the Airvo 3 to avoid electrical shock and flammability hazards.
- Do not place the pulse oximetry accessories on electrical equipment that may affect the device, preventing it from working properly.
- To minimize radio interference, other electrical equipment that emits radio frequency transmissions should not be used near the pulse oximetry accessories.
- A functional tester cannot be used to assess the accuracy of a pulse oximeter or sensor.

Nonin:

- The Nonin Xpod USB connector has motion tolerant software that minimizes the likelihood of motion artefact being misinterpreted as good pulse quality. In some circumstances, however, this device may still interpret motion as good pulse quality. This covers all available outputs (i.e. SpO₂, PR, PLETH, PPG).

Note

- For more information about required safety and regulatory requirements for pulse oximeters, refer to ISO 80601-2-61, and IEC 60601-1. Additional safety information can be found in the labelling provided with each Nonin sensor.

3. Overview

This section shows the Airvo 3 system and compatible accessories.

3.1 Identifying system components

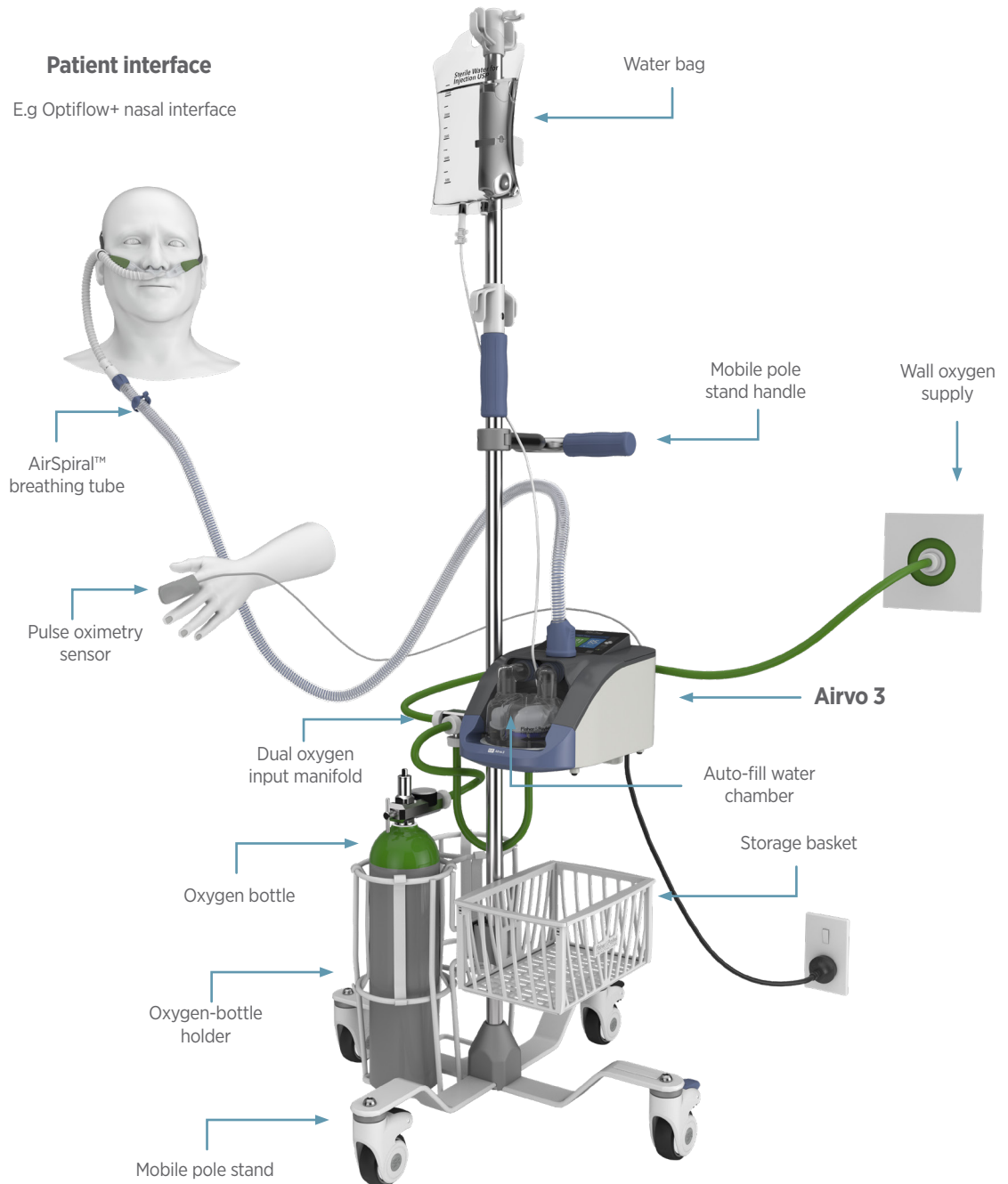

The Airvo 3 System

3.2 Identifying device components

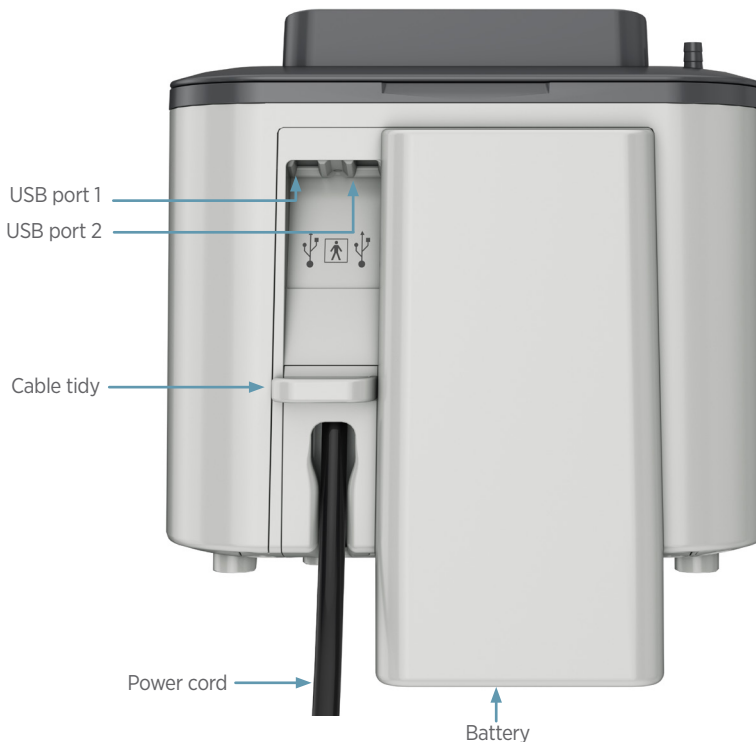
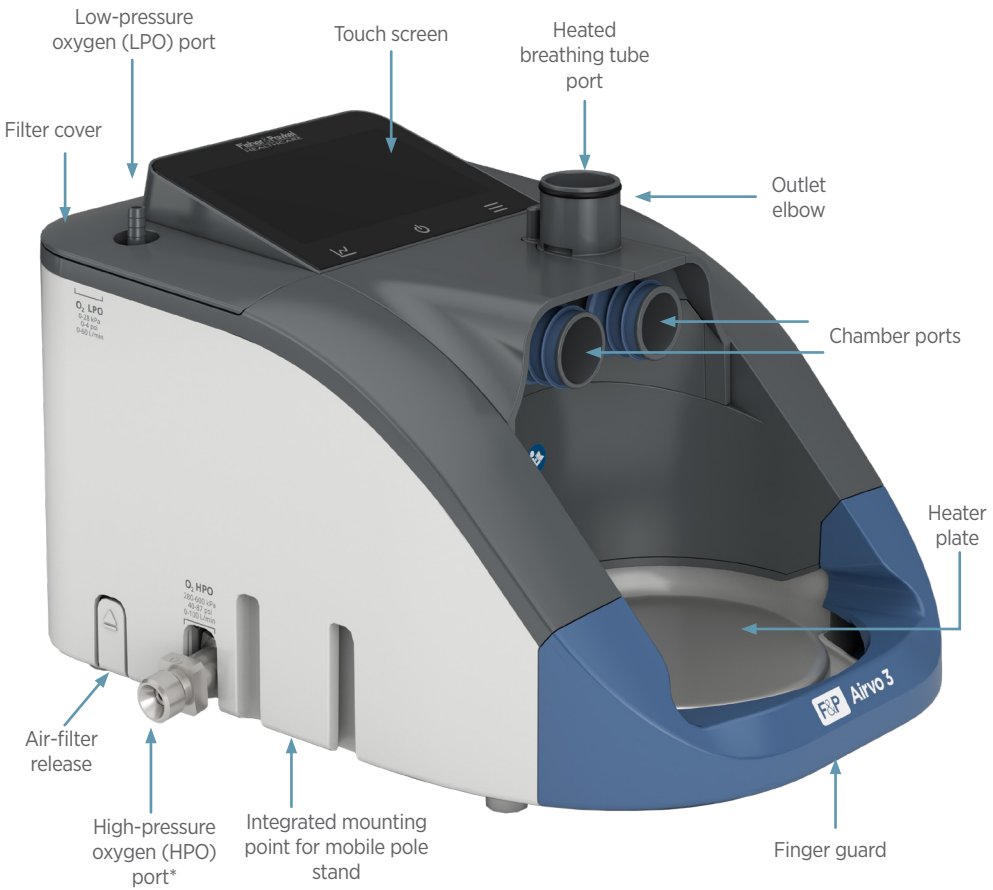

*HPO connection may vary depending on regional selection of connector type (DISS, NIST or SIS)

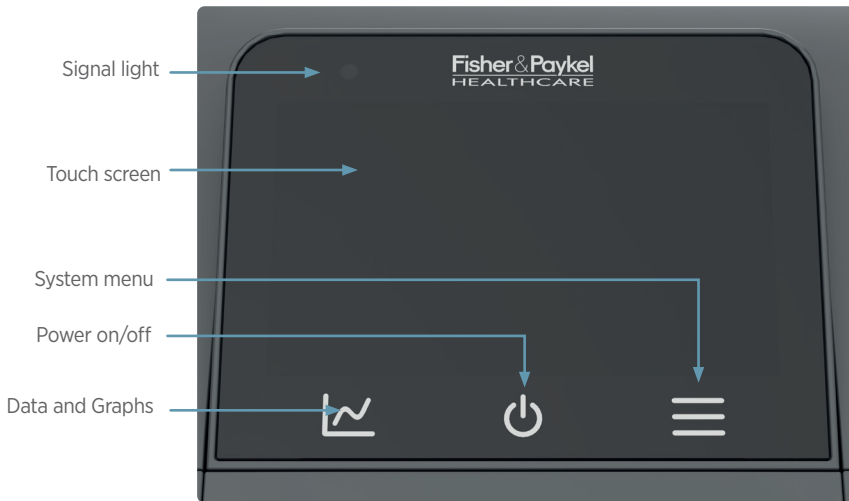

3.3 Navigating the user interface

The Airvo 3 touch screen provides access to therapy and device status, settings and alarms. You interact with the user interface by:



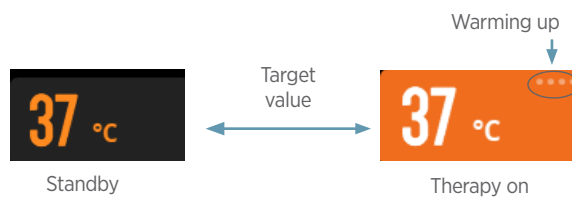
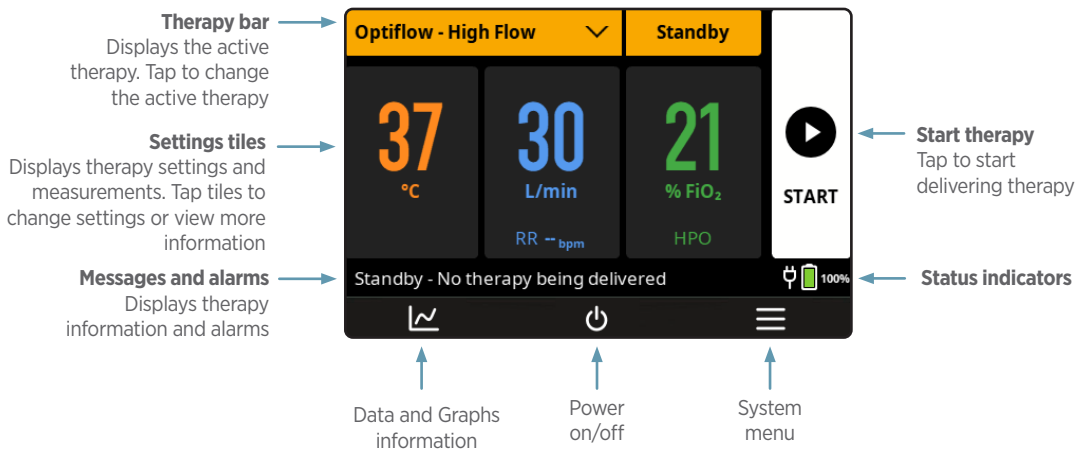

- touching elements on the screen to open setting screens, make selections and change values, and
- swiping up/down to scroll through menus that are only partly displayed.

3.3.1 Home screen













3.3.2 Message bar

The Message bar shows the current state of therapy delivery, confirms settings changes and displays alarms. Example messages are shown in the table below.

Message bar	Description
	Breathing gases are not being delivered to the patient. Tap the Start button to begin therapy.
	Breathing gases are being delivered. Tap the Stop button to return to stop therapy and return to standby mode.
	Active alarms are displayed on top of other messages. Tap the alarm for details or press  to temporarily pause the alarm audio. See section 7 for troubleshooting alarms.

3.3.3 Status indicators

The following icons may be displayed in the Message bar.

Icon	Description
	Audio pause
	The Airvo 3 is being powered from an AC power supply
	Status of the internal battery:
	50% of the battery charge is remaining
	Battery is charging and 50% of the charge is remaining
	Battery is not charging properly*
	Battery is missing or faulty*
	Battery is due for replacement*
	Touch display is locked to prevent accidental changes
	An Airvo 3 USB storage device is connected to one of the USB ports

*Check the battery is properly installed. Replace the battery if the problem persists.

3.3.4 Signal light

The signal light flashes when any alarm is active. Its color indicates the highest priority alarm that is active. See section 7 for troubleshooting alarms.



3.3.5 System menu

The system menu provides access to additional settings and information.

Tap  to open the system menu when the Home screen is displayed.

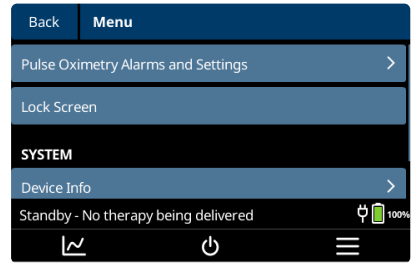

Menu item	Description
Pulse Oximeter Alarms and Settings	Configure the pulse oximetry settings including SpO ₂ .
Lock Screen	The lock screen can prevent accidental settings changes.
Device Info	Displays the version information.
System Settings	Change advanced Airvo 3 settings, limits and behaviors. Refer to the Airvo 3 Technical Manual for more information.

3.3.6 Data and Graphs screen

The Data and Graphs screen displays current and previous measurements and settings for the current patient.

Tap  to open the Data and Graphs screen when the Home screen is displayed. The values available depends on the active therapy mode.

4. Preparing the Airvo 3

Review the safety information in section 2 before proceeding. Refer to appendices 1 – 3 for a list of consumables and accessories that have been validated for use with the Airvo 3.

4.1 Equipment required

You will need:

- Airvo 3 attached to a mobile pole stand,
- clean and disinfected outlet elbow,
- bag of USP sterile/distilled water for inhalation (or equivalent).

Outlet elbows can be processed in two different ways:

Disinfection kit (900PT600)

For hospitals using the disinfection kit for reprocessing: A clean and disinfected outlet elbow will already be installed in the Airvo 3. Remove the clean storage cover and/or the red disinfection tube before use.

Washer-disinfector

For hospitals using a washer-disinfector for reprocessing: obtain a clean and disinfected outlet elbow, e.g. from your Central Sterile Services Department (CSSD) system.

If supplementary oxygen is prescribed for your patient, you will need either:

- a high-pressure oxygen hose to connect the Airvo 3 to the wall oxygen supply or an oxygen-bottle regulator, or
- low-pressure oxygen tubing to connect the Airvo 3 to a flowmeter.

⚠ Warnings

Only use patient consumables and accessories that are compatible with the Airvo 3 (see Appendix 1-3).
Do not modify patient consumables or accessories in any way.

4.1.1 Optiflow high flow therapy

To provide Optiflow high flow therapy, you will need a:

1. Breathing tube and chamber kit.
2. Optiflow patient interface.

Refer to Appendix 1 for a list of compatible consumables.

Nasal interface

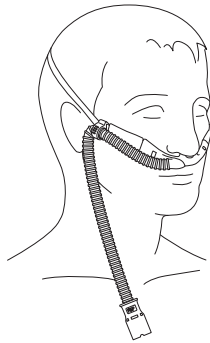

Optiflow+
Optiflow 3S



Optiflow Junior 2
Optiflow Junior 2+

Tracheostomy interface

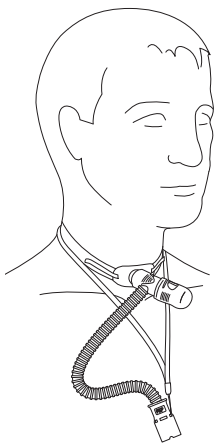

Optiflow+ tracheostomy interface

Mask adapter interface

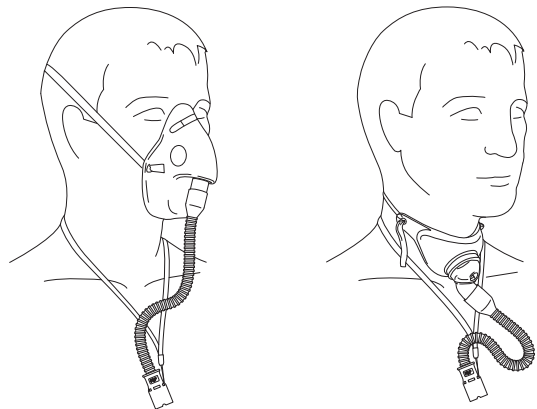

Optiflow+ mask interface adapter

4.2 Airvo 3 setup

Standard aseptic techniques should be followed to minimize contamination when handling the Airvo 3 and accessories.

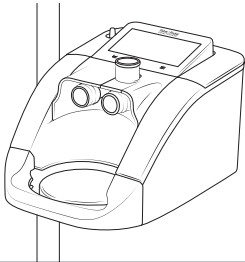

1. Check Airvo 3 height

Check that the Airvo 3 is attached securely to the mobile pole stand and is below the patient's head height.

Position the Airvo 3 so that the power cord connection to the wall power supply is easily accessible and can be disconnected if necessary.

Caution

Do not place the Airvo 3 where controls can be changed by the patient.

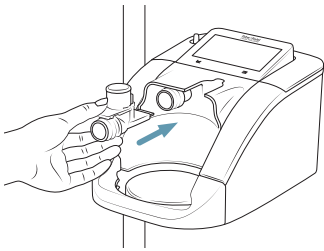

2. Connect the outlet elbow (if applicable)

This step applies if your hospital uses a washer-disinfector to clean and disinfect the outlet elbow. This step does not apply if your hospital uses the disinfection kit (900PT600).

Insert the clean, disinfected outlet elbow into the slot on the top of the Airvo 3.

Warning

Make sure the Airvo 3 is off when connecting the outlet elbow.

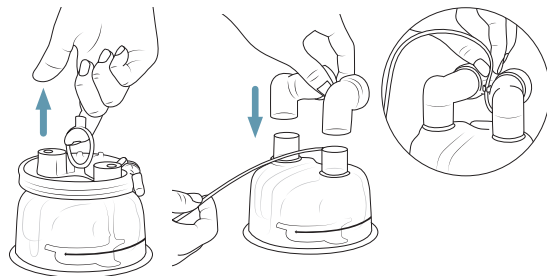

3. Assemble the water chamber

Open the tube and chamber kit and remove the MR290 auto-fill water chamber and chamber adapter.

Remove the blue port caps from the chamber by pulling the tear tab upwards then remove the bracket holding the water supply tube.

Fit the supplied adapter over the two vertical ports on the chamber and push on fully then clip the water supply tube into position.

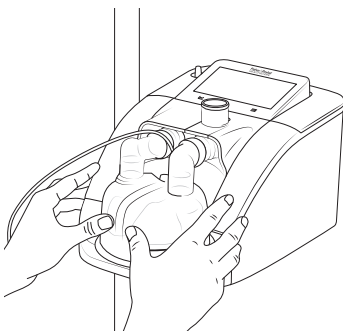

4. Insert the water chamber

Fit the water chamber to the Airvo 3, sliding the chamber past the finger guard onto the heater-plate. Take care to align the port adapter with the blue ports on the Airvo 3.

Ensure the water chamber is fully inserted by pushing firmly on the front of the chamber until it slides past the finger guard.

To remove the water chamber, grip the port adapter and pull the chamber away from the Airvo 3.

Warnings

To avoid burns:

Do not start therapy without the water chamber in place.

Do not touch the heater-plate, water chamber or chamber base during use.

Exercise caution when removing and emptying the chamber. The water in the chamber is hot during use.

To avoid electrical shock:

When handling the Airvo 3 with the water chamber in place, avoid tilting the device to prevent any chance of water entering the unit enclosure

Do not use the MR290 auto-fill water chamber if it has been dropped, allowed to run dry or damaged in any way. This could lead to the chamber overflowing.

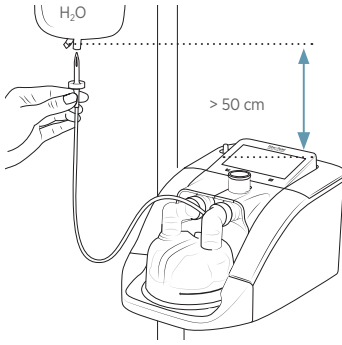

5. Connect the water bag

Attach the sterile water bag to the hanging bracket 50 cm above the Airvo 3. Remove the spike from the chamber bracket and push the bag spike into the fitting at the bottom of the bag.

Open the vent cap on the side of the bag spike.

⚠ Caution

Only use USP sterile/distilled water, suitable for inhalation, to fill the water chamber. Adding other substances can adversely affect the humidifier and therapy delivered.

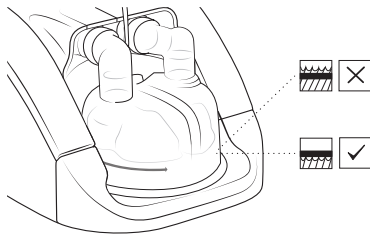

6. Check the water level

Check that water flows into the chamber and remains below the maximum water-level line.

The chamber will automatically maintain the correct water level until the water bag is empty.

⚠ Caution

Do not use the MR290 auto-fill chamber if the water level rises above the maximum water-level line. This may lead to water entering the patient's airway.

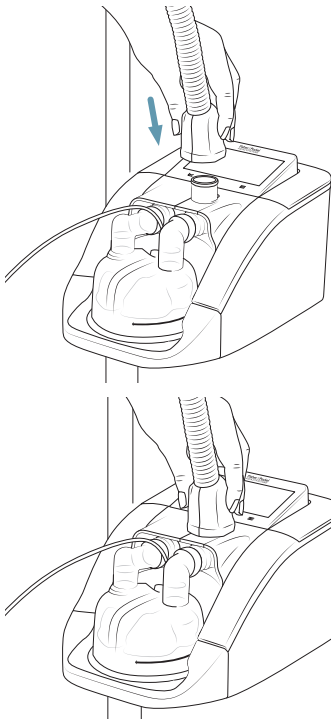

7. Install the breathing tube

Connect the breathing tube by lining up the pins on top of the Airvo 3, pushing down until you hear a click and the tube locks into place.

To remove the breathing tube, squeeze the sides of the connector and pull up.

⚠ Warnings

To avoid burns:

Do not use an insulating sleeve or any similar accessories which are not recommended by Fisher & Paykel Healthcare.

ⓘ Note

Make sure the outlet elbow is installed in the Airvo 3 before attaching the heated breathing tube.

See step 2 "Connect the outlet elbow (if applicable)" above.

This step applies if your hospital uses a washer-disinfector to clean and disinfect the outlet elbow.

This step does not apply if your hospital uses the disinfection kit (90OPT600).

Insert the clean, disinfected outlet elbow into the slot on top of the Airvo 3.

4.3 Supplementary oxygen

The Airvo 3 provides two options for connecting supplementary oxygen:

1. A high-pressure oxygen (HPO) inlet port, and
2. A low-pressure oxygen (LPO) inlet port.

The high-pressure oxygen inlet port is connected to the wall oxygen supply or to the pressure regulator on an oxygen bottle. The ability of the Airvo 3 to provide the target FiO_2 is limited by the line pressure of the high-pressure inlet port (HPO). If the Airvo 3 is unable to maintain the target FiO_2 , the device will generate a “ FiO_2 Below Target” alarm.

The low-pressure oxygen inlet port is connected to an external flowmeter, typically a rotameter.

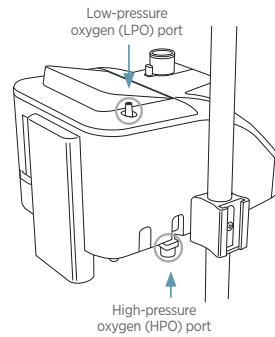

Warnings

You must take special care when using supplementary oxygen to reduce the risk of fire. Keep all sources of ignition away from the Airvo 3 and, preferably, not in the same room as the Airvo 3 during use.

Do not use supplementary oxygen while smoking, near sparks or open flames.

When using bottled oxygen, ensure the volume remaining in the bottle is sufficient for the therapy planned.

Connect only pure oxygen gas to the oxygen inlet ports on the Airvo 3. The oxygen concentration displayed will be wrong if any other gas, or mixtures of gases, is connected.

The oxygen concentration delivered to the patient can be affected by changes to the oxygen setting, patient interface or obstructions in the air path.

Only use lotions and/or salves that are labeled as oxygen-compatible to avoid the risk of fire and burns.

Appropriate patient monitoring must be used at all times.

Make sure that all oxygen connectors are tightened sufficiently to prevent leaks.

As the low-pressure oxygen (LPO) inlet port uses an alternative small-bore connector design different from those specified in the ISO 80369 series, there is a possibility that a misconnection can occur with a medical device using a different alternative small-bore connector, which can result in a hazardous situation causing harm to the patient. Special measures need be taken by the user to mitigate these reasonably foreseeable risks.

Caution

Do not connect an oxygen supply to both the high-pressure oxygen inlet port and the low-pressure oxygen inlet port at the same time. Using the low-pressure inlet at the same time as the high-pressure inlet may cause incorrect oxygen delivery and a FiO_2 Above Target alarm.

Note

The built-in oxygen analyzer uses ultrasonic measurement technology. It does not require in-field calibration.

4.3.1 High-pressure oxygen (HPO) source

When oxygen is connected to the HPO port, the Airvo 3 directly controls the oxygen input to meet the target FiO₂ setting.

4.3.2 Low-pressure oxygen (LPO) inlet port

When using the LPO port, the amount of oxygen taken in by the Airvo 3 is controlled by an external flowmeter.

Connect a tube from the external flowmeter to the LPO port. Make sure that the flowmeter is turned off whenever the Airvo 3 is not delivering therapy.

When using the low-pressure oxygen inlet port, monitor the oxygen concentration displayed on the Home screen. The oxygen flow-regulator must be adjusted manually to maintain the prescribed oxygen concentration when changing the respiratory gas flow rate.

Clinicians may configure a High FiO₂ alarm to discourage use of high FiO₂ values in particular clinical environments.

The High FiO₂ alarm can be disabled or a threshold between 30% and 95% can be selected when the Airvo 3 is initially set up for your environment (see Oxygen high alarm threshold, Airvo 3 Technical Manual). The alarm threshold is displayed on the Titrate FiO₂ screen, if enabled. Tap the FiO₂ tile to open the Titrate FiO₂ screen.

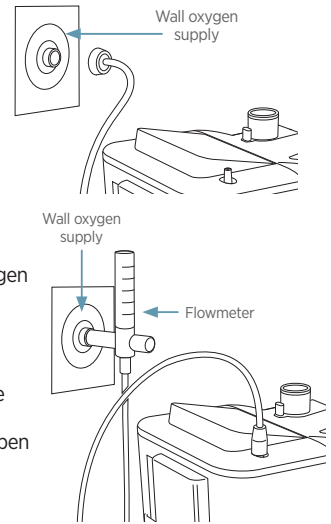

Warning

During Optiflow high flow therapy, the fraction of oxygen inspired by the patient will be lower than the value displayed on the FiO₂ tile if the patient's peak inspiratory demand exceeds the flow delivered.

Turn off the low-pressure oxygen source whenever the Airvo 3 is not delivering therapy, to ensure that oxygen does not build up inside the device

4.4 Additional setup for pulse oximetry

Connect the pulse oximetry USB connector cable to either USB port on the back of the Airvo 3. Clip the cable into the cable tidy so that it is not pulled out accidentally. A pop up screen on the Airvo 3 will appear to select the compatible pulse oximeter that has been connected.

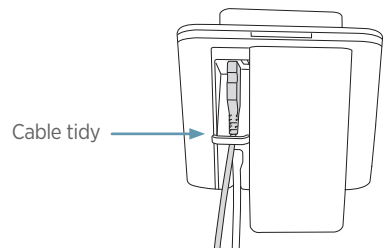

4.4.1 Pulse oximetry accessories

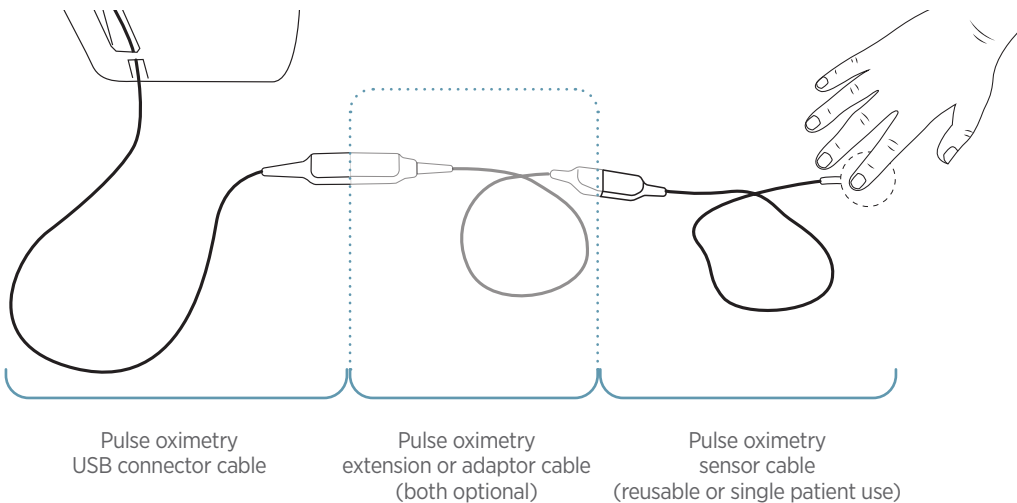

Warnings

Use only compatible oximetry sensors and accessories for SpO₂ and pulse rate measurements. Verify compatibility before use to avoid incorrect operation of your Airvo 3, inaccurate measurements and/or patient injury. See Appendix 3 for a list of compatible accessories.

Do not use single-patient-use pulse oximeter sensors on more than one patient to avoid cross-infection and/or contamination.

Follow the user instructions supplied with multi-use pulse oximeter sensors, adapters and USB connector cables to clean and disinfect these devices between patients to avoid cross-infection and/or contamination.

5. Using the Airvo 3

5.1 Getting started

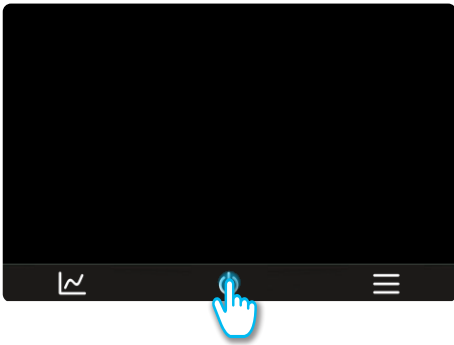

Turn on the Airvo 3

Plug the Airvo 3 power cord into the wall power supply.

Lock the wheels of the mobile pole stand to prevent the Airvo 3 from moving.

Turn on the Airvo 3 by holding down the Power on/off button for 2 seconds.

Warning

Make sure the Airvo 3 is dry before plugging the power cord into the wall power supply to avoid a potential electric shock.

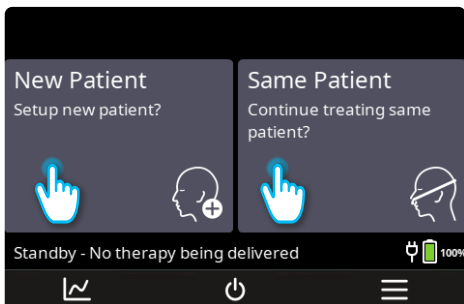

Review disinfection state

The Airvo 3 will ask you if it will be used on:

the same patient who last used the device (tap Same Patient)

OR

a new patient (tap New Patient).

For a new patient, check that:

1. The outlet elbow has been cleaned and disinfected.
2. A new tube and chamber have been installed.

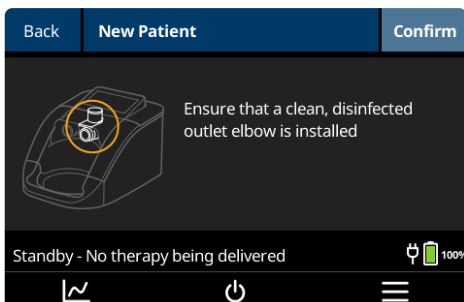

Warnings

The Airvo 3 must be cleaned and disinfected between patients. Refer to section 8 for the steps required to reprocess the Airvo 3 between patients.

Do not exceed the maximum use period for single-patient-use accessories and consumables (see section 8.3 for the schedule for changing accessories).

5.2 Optiflow high flow therapy settings

The default range of Optiflow high flow therapy settings is shown below. Some settings may have been limited, or disabled, when the device was initially set up for its intended clinical environment. Refer to the Airvo 3 Technical Manual for details.

Settings are persistent and will retain their previous value when the Airvo 3 is turned on. Selecting New Patient when reviewing the disinfection state (see section 5.1 above) applies the default values for its intended clinical environment to all settings.

Setting	Range	Description
Target humidity	31 – 37 °C	Target humidity for the respiratory gas supplied to the patient.
Target flow	2 – 70 L/min	Flow rate of the respiratory gas supplied to the patient.
FiO ₂	21 – 100%	Target oxygen concentration for the breathing gases when an external oxygen supply is connected to the high-pressure oxygen inlet port.
Expiratory relief (Target flow tile)	Off, 10%, 20%, 30%	This setting is disabled by default, refer to the Airvo 3 Technical Manual for details. Expiratory relief automatically reduces the respiratory gas flow rate during exhalation and returns it to normal during inhalation. Indicative flow rates are displayed on the settings screen. These may differ depending on the method and strength of the patients breath.

Tiles on the Home screen show current Optiflow high flow therapy settings and measurements. Only tiles relevant to connected accessories are shown.

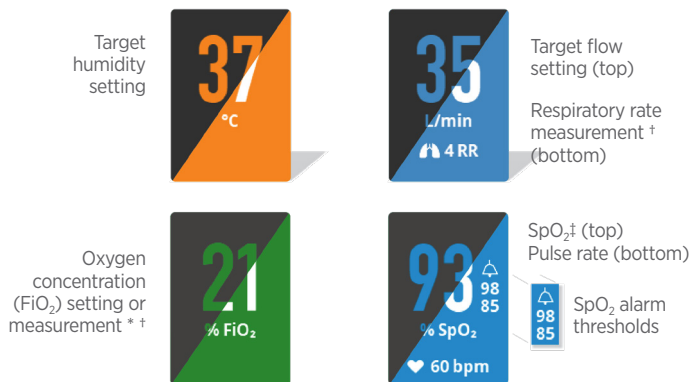
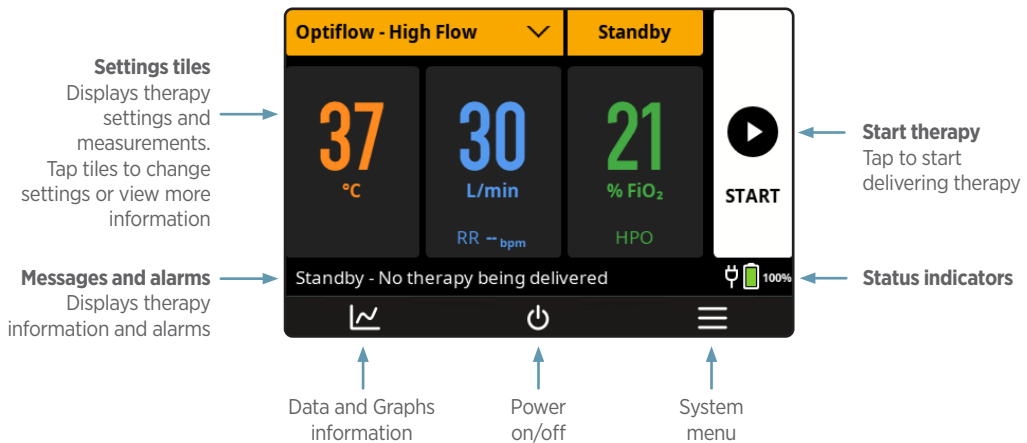

* The FiO₂ tile shows the breathing gas oxygen concentration setting when supplementary oxygen is connected to the high-pressure oxygen (HPO) inlet port and measured oxygen concentration when connected to the low-pressure oxygen (LPO) inlet port. Measured oxygen concentration is not available in standby mode.

† “--” is displayed when a value is not available; values are gray when signal quality is poor.

‡ The SpO₂ tile is displayed automatically when a compatible pulse oximeter is connected.

Follow the steps below to start delivering Optiflow high flow therapy. Some settings may have been limited, or disabled, when the device was initially set up for your clinical environment. Refer to the Airvo 3 Technical Manual for details.

5.3 Starting Optiflow high flow therapy

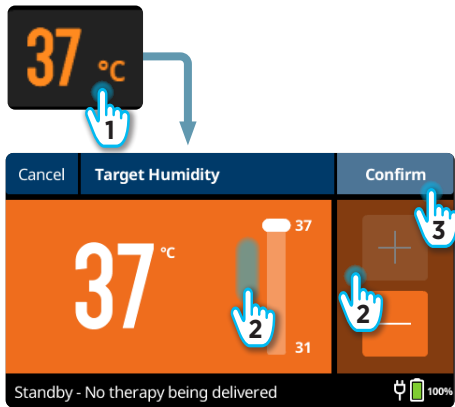

Adjust target humidity

1. Tap the target humidity tile to open the Target Humidity screen.
2. Use the + / - buttons or slider to select a desired target humidity.
3. Tap Confirm to apply the change and return to the Home screen. Tap Cancel to discard any changes.

⚠ Warnings

Airvo 3 is classified as a Category 1 humidifier for patients with bypassed airways (tracheostomies) in the following modes only: 37 °C and 10-60 L/min. Do not use any other mode for patients with bypassed airways (tracheostomies).

ⓘ Note

Patients using face masks may find high temperatures uncomfortable. Consider a target temperature of 31 °C .

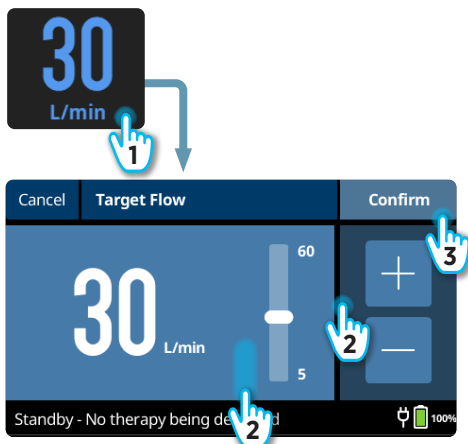

Adjust target flow

1. Tap the target flow tile to open the Target Flow screen.
2. Use the + / - buttons or slider to select the desired flow.
3. Tap Confirm to apply the change and return to the Home screen. Tap Cancel to discard any changes.

An appropriate flow rate for your patient should be prescribed following hospital protocols.

Recommended flow rates are shown below.

Patient population	Age	Recommended flow rate
Neonatal	0 – 28 days	2 – 8 L/min
Infant	1 – 24 months	2 – 25 L/min
Child	2 – 12 years	2 – 36 L/min
Adolescent	12 – 22 years	10 – 70 L/min
Adult	≥ 22 years	20 – 70 L/min

ⓘ Note

Refer to the patient interface user instructions for details.

The following table shows the target flow settings able to be used with these interfaces.

PATIENT INTERFACE		L/min																	
		2	3	4	5	6	7	8	9	10	15	20	25	...	50	55	60	65	70
Optiflow Junior 2	OJR414 M	2		7															
	OJR416 L	2		20															
	OJR418 XL	2		25															
	OJR520 XXL									10		50							
Optiflow+	OPT942/OPT1042 S									10		60							
Optiflow 3S	OPT944/OPT1044 M									10		70							
	OPT946/OPT1046 L									10		70							
	OPT970									10		60							
	OPT980									10		60							

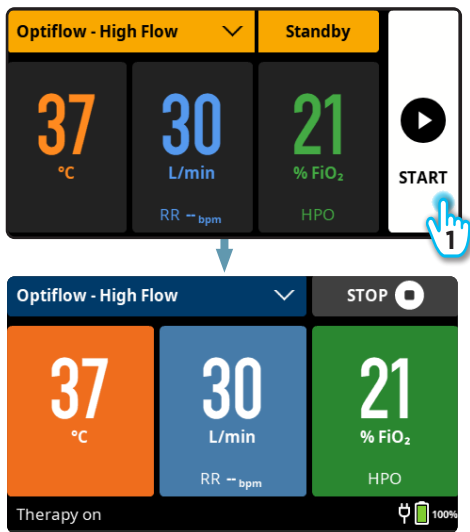

Start therapy

Check that the breathing tube is assembled correctly and all connections are secure. Check the alarms are operating properly according to the instructions in section 7.5.

1. Tap the START button to begin therapy. The Airvo 3 will play a short melody and display the message “Warmed up”.

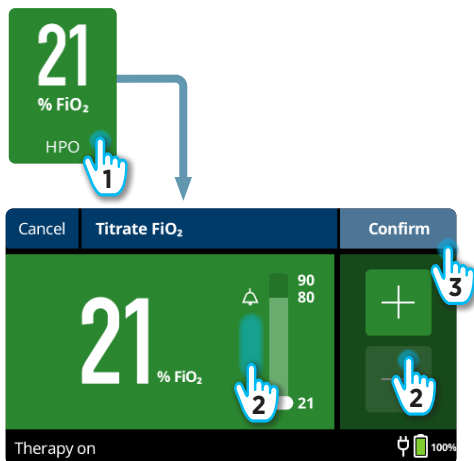

Adjust supplementary oxygen (optional)

Warning
 Use continuous SpO₂ monitoring on patients who would desaturate significantly if their oxygen supply is disrupted.

Oxygen connected to the high-pressure inlet port (HPO)

1. Tap the FiO₂ tile to open the Titrate FiO₂ screen.
2. Use the + / - buttons or slider to select the desired FiO₂.
3. Tap Confirm to apply the change and return to the Home screen. Tap Cancel to discard any changes.

The Airvo 3 will automatically adjust oxygen flow to maintain the selected FiO₂.

Oxygen connected to the low-pressure inlet port (LPO)

The Airvo 3 does not directly control FiO_2 .
Use an external flowmeter to adjust FiO_2 to the prescribed level.
The oxygen tile displays measured FiO_2 .

! Note

It may take a few minutes for the oxygen measurement to stabilize.
The external flowmeter will need to be readjusted following changes to Airvo 3 target flow.

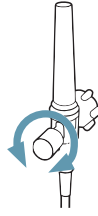

High FiO_2 alarm

Clinicians may configure a High FiO_2 alarm to discourage the use of high FiO_2 values in particular clinical environments. See the Airvo 3 Technical Manual for setup details.

If the alarm is enabled, the alarm threshold is displayed on the Target FiO_2 screen.

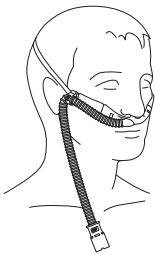

5. Fit the patient interface

Fit the patient interface to your patient following the user instructions supplied with the interface. Take care to follow all warnings and cautions.

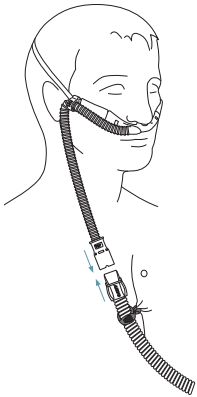

6. Connect to the patient interface

Connect the patient interface to the connector at the end of the breathing tube.

The patient may be connected to the heated breathing tube immediately. When therapy initiation is not urgent, it is recommended to wait until the Airvo 3 plays a short melody and displays "Therapy On" in the Message bar.

Attach the breathing tube clip to the patient's clothing.

! Warnings

Do not allow the breathing tube to remain in direct contact with the patient's skin for long periods of time to avoid the risk of burns. The healthcare professional shall assess the conditions for safe contact, such as duration and skin condition.

Do not cover or add heat above ambient levels to any part of the breathing tube or interface e.g. by covering with a blanket or by heating with infrared radiation, an overhead heater, or an incubator.



! Caution

Keep the heated breathing tube away from electrical monitoring leads (e.g. EEG, ECG/EKG, EMG, pulse oximeter) to reduce the risk of interference with the signal monitored.

! Note

The air may feel warm when your patient starts using the Airvo 3. This is normal. The patient should continue to breathe normally.

5.4 During therapy

Monitor the patient following hospital protocols and clinical judgement. Ensure you can hear and respond to any device alarms.

If there is an interruption to the power supply, and the battery is depleted, the Airvo 3 will raise a Power Out alarm and if power is not restored it will turn off and not deliver any therapy to the patient. Once power is restored the Airvo 3 can be restarted and will retain the previous therapy and alarm settings.

Warning



If using the battery as the power source, periodically check the battery status to ensure the battery does not become depleted while therapy is being delivered.

5.4.1 Lock Screen (optional)

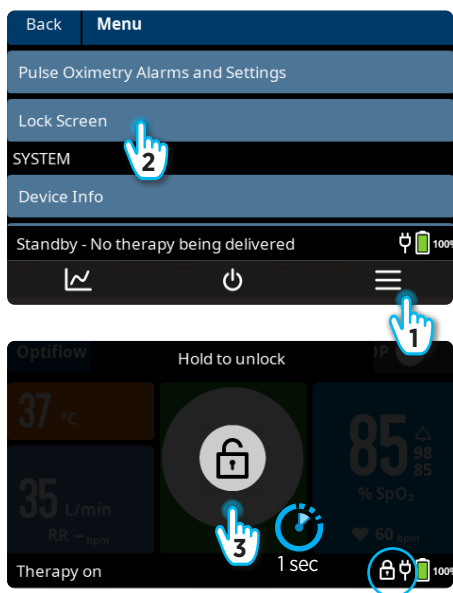
The lock screen can prevent accidental settings changes.



To enable the lock screen:

1. Tap  to open the system menu.
2. Select Lock screen from the system menu.
The symbol  is shown in the Message bar.

To disable the lock screen:

3. Touch the screen while it is locked, then hold the Unlock icon for one second.

5.4.2 Monitor and adjust settings

Adjust settings as needed. Most changes take effect after pressing the confirmation button but it may take a few minutes for some settings, such as target temperature, to respond to changes. Tiles show an animated ellipsis symbol (...) to indicate that a therapy setting has not yet reached its target.

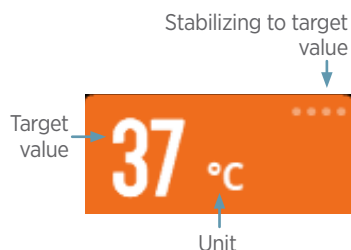

5.4.3 Manage condensation

Drain excess condensate from the breathing tube by:

1. Disconnecting the breathing tube from the patient interface, and
2. lifting the patient end of the tube so the condensate runs into the water chamber

Reduce the flow rate below 30 L/min if the condensate does not run freely into the water chamber. Return the flow rate to the prescribed setting after draining the breathing tube.

Direct cold air away from the heated breathing tube where possible. Air conditioners, fans, open windows and other sources of cold air may increase condensation.

Consider reducing the target humidity if condensation persists.

5.4.4 Pulse oximetry

The Pulse Oximetry tile will be automatically displayed on the Home screen when a compatible pulse oximetry USB connector cable is connected to the Airvo 3.

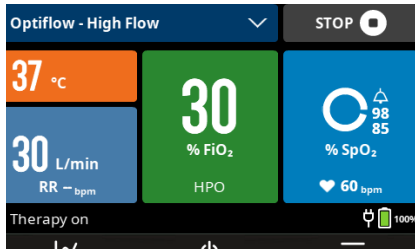

Pulse oximetry measurements and status are shown as follows:

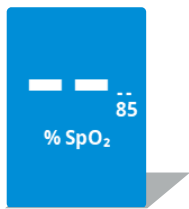

Pulse oximetry is connected to the Airvo 3, but the sensor is not attached to a patient.

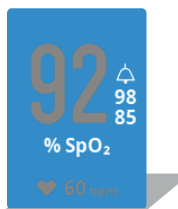

Poor signal quality may be causing inaccurate measurements (see section 7 for troubleshooting).

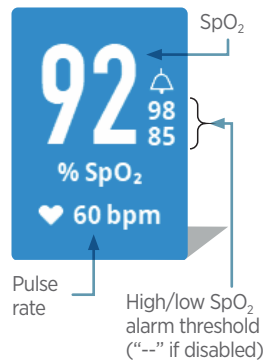

Tap the Pulse Oximetry tile to open the Pulse Oximetry screen.

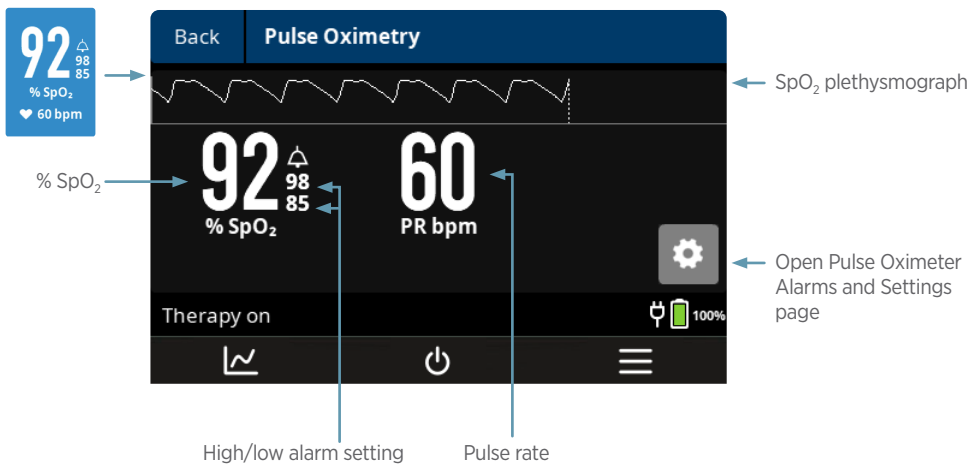

Warnings

Nonin:

The Nonin Xpod USB connector is designed to determine the percentage of arterial oxygen saturation of functional haemoglobin. Factors that may degrade pulse oximetry performance or affect the accuracy of the measurement including the following:

- Excessive ambient light
- Excessive motion
- Electrosurgical interference
- Elevated levels of dyshemoglobin
- Blood flow restrictors (arterial catheters, blood pressure cuffs, infusion lines, etc.)
- Moisture in the sensor
- Improperly applied sensor
- Incorrect sensor type
- Poor pulse quality
- Venous pulsations
- Anemia or low haemoglobin concentrations
- Cardiogreen or other intravascular dyes
- Carboxyhemoglobin
- Methemoglobin
- Dysfunctional haemoglobin
- Artificial nails or fingernail polish
- A sensor not at heart level

Loss of monitoring can result if any objects hinder the pulse measurement. Ensure that no blood flow restrictors (e.g., blood pressure cuff) hinder pulse measurements.

The oximeter sensor may not work on cold extremities due to reduced circulation. Warm or rub the finger to increase circulation, or reposition the sensor.

Inaccurate readings can result due to residue (e.g. dried blood) in light path or degradation of optical characteristics of sensor components. Refer to cleaning instructions supplied with the pulse oximetry accessories.

False high readings can result if SpO₂ is low due to dysfunctional hemoglobin (e.g. carboxyhemoglobin or methemoglobin).

Read the instructions supplied with the pulse oximetry accessories for additional safety information (including any potential risks or adverse effects from sensor materials), measurement site selection, detailed sensor setup, maximum sensor application time at a single site before repositioning, cable lifetime, sensor lifetime, factors that can interfere with measurement, troubleshooting and maintenance instructions.

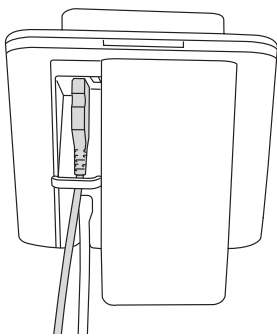

Connect sensor to Airvo 3

Connect the pulse oximeter USB connector cable to the USB port on the back of the Airvo 3. Connect the pulse oximetry sensor cable into the USB connector cable. On first connection a selection popup screen will appear. Select the type of pulse oximeter that has been connected.

Warning

Carefully route cabling to reduce the possibility of patient entanglement or strangulation.

Caution

The accuracy of the SpO₂ measurement may be affected if the total sensor cable length (including extension cables) is greater than 3 meters.

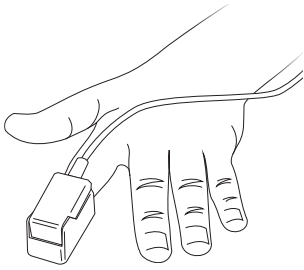

Attach sensor to patient

Carefully select a pulse oximetry sensor based on the patient's age, weight and intended sensor application site. More information can be found in the instructions supplied with each sensor.

Warnings

Tissue damage may be caused by incorrect application of the sensor, e.g. by wrapping the sensor too tightly. Follow the instructions supplied with the sensor for correct application.

Use only compatible oximetry sensors and accessories for SpO₂ and pulse rate measurements. Verify compatibility before use to avoid incorrect operation of your Airvo 3, inaccurate measurements and/or patient injury. See Appendix 3 for a list of compatible accessories.

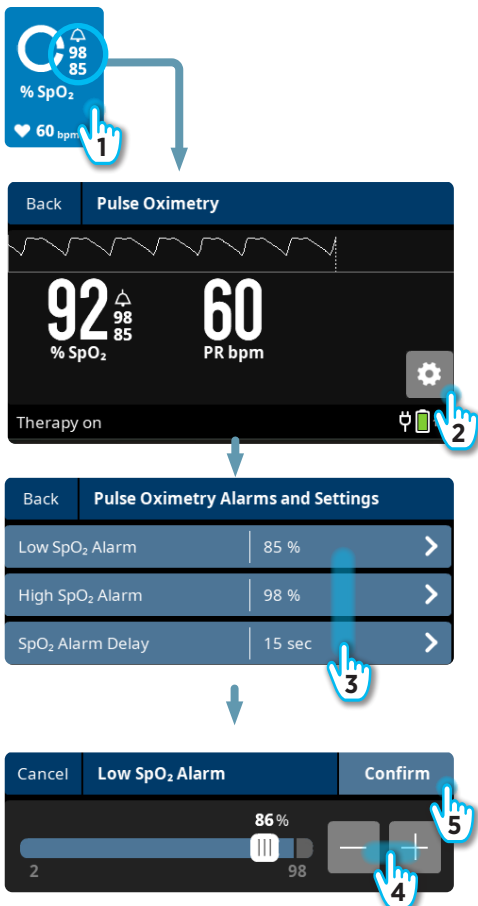

Set alarm limits

Review and set suitable alarm thresholds for the SpO₂ Low alarm and SpO₂ High alarm.

To view alarm settings:

1. Tap the Pulse Oximeter tile to open the Pulse Oximetry screen,
2. Tap  to open the Pulse Oximeter Alarms and Settings.
3. Tap the desired setting, scrolling if necessary,
4. Use the + / - buttons to select the required value,
5. Tap Confirm to apply the change or Cancel to discard any changes and return to the settings list.

Tap Back twice to return to the Home Screen when you have finished making changes.

See section 9 for more information on advanced pulse oximeter settings.

Warning

Check that the pulse oximetry alarm limits are appropriate for the patient being monitored every time pulse oximetry is used.

Caution

Pulse oximeter alarms are not active until valid patient data has been received from the pulse oximeter.

If the Airvo 3 loses power and the battery is depleted, pulse oximetry functionality will be lost. It will be restored once power is restored to Airvo 3.

A "Pulse Oximeter Sensor Off Patient" alarm will be raised if the pulse oximeter sensor cannot detect a patient signal. Either:

1. Tap the Alarm Reset button to acknowledge the alarm and continue without SpO₂ monitoring, or
2. Reposition the sensor to recover the patient signal.

SpO₂ monitoring will restart automatically when the patient signal is detected.

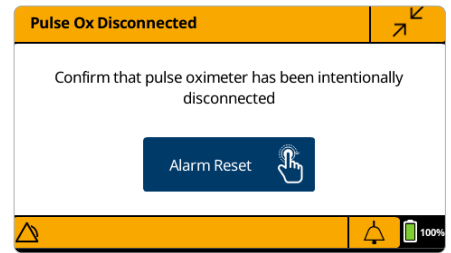

Warnings

Periodically reposition the sensor to help prevent ischemia.

If any measurement seems questionable, first check the patient's vital signs by alternate means. Then check the pulse oximeter USB connector, adapter, sensor, and Airvo 3 for proper operation.

Caution

Inspect the sensor application site at least every 6 to 8 hours to ensure correct sensor alignment and skin integrity. Patient sensitivity may vary due to medical status or skin condition. Discontinue use of adhesive tape sensors if the patient exhibits an allergic reaction to the adhesive material.

5.5 Mobility and battery operation

The HPO (High Pressure Oxygen) dual-input manifold and internal rechargeable battery provide continuity during intra-hospital transport. Reduced humidity will be delivered when the Airvo 3 is being powered only by the battery; for more details see Appendix 4. The HPO (High Pressure Oxygen) dual-input manifold uses the oxygen supply with the highest pressure.

When transporting the Airvo 3 with your patient:

1. Adjust therapy settings as necessary for intra-hospital transport.
2. If using supplementary oxygen:
 - Check that the oxygen bottle contains enough oxygen for your journey.
 - Turn on the oxygen-bottle pressure regulator.
 - Disconnect the oxygen hose from the wall supply. Either attach it to a second oxygen bottle for longer trips or hook it over the Airvo mobile pole stand if additional oxygen is not required.

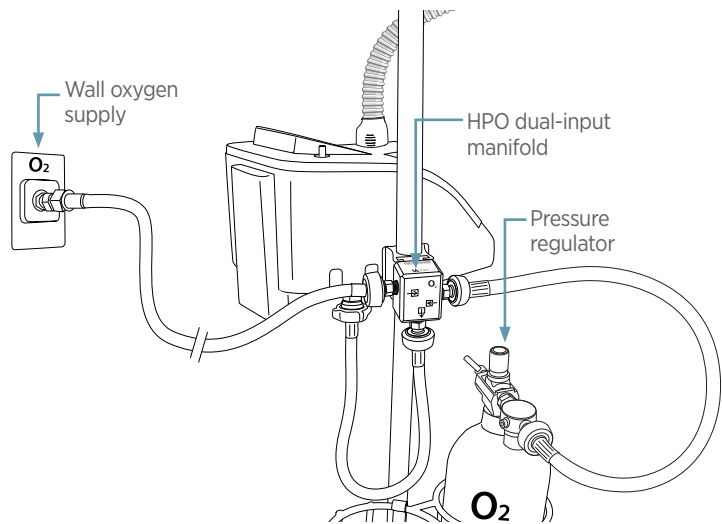

The oxygen dual-input block will use the oxygen-bottle supply automatically.

Check the battery contains enough charge for intra-hospital transport. A fully charged battery will provide therapy for about 40 minutes. A Low Battery alarm will occur when 35% of the battery is remaining (no changes to the device).

A Critically Low Battery alarm will occur when 20% of the battery is remaining (humidity is turned off, oxygen and flow are still running). When the battery is fully depleted, the Airvo 3 will shut down (and produce a Power Out alarm). If power is restored before the device shuts down, the Airvo 3 will automatically restart.

3. Unplug the Airvo 3 from the wall power.
4. The Airvo 3 will display a Battery Mode Low Humidity alarm.
5. When you reach your destination:
 - Reconnect the Airvo 3 to the wall power supply and the wall oxygen supply.
 - Turn off the oxygen bottle pressure regulator to avoid draining the oxygen bottle and switch to the wall oxygen supply.

If you are not using the oxygen dual-input block, connect an oxygen bottle (if required) to one of the oxygen inlet ports when transporting your patient. Ensure any oxygen supply connected to the low-pressure oxygen (LPO) inlet port is turned off when the device is in standby mode, not delivering therapy.

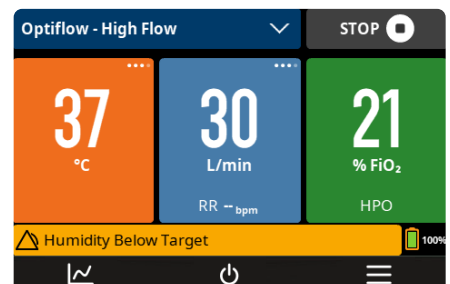

Warnings

Only use the Airvo 3 battery with the Airvo 3 device. Only charge the Airvo 3 battery with the Airvo 3 device.

Loss of power will result in loss of therapy. In the event of a Critically Low Battery alarm, promptly connect the Airvo 3 to the wall power supply to avoid loss of therapy due to the battery becoming depleted.

Contact technical personnel to remove the battery from the device if it is not likely to be used for an extended period of time.

5.6 Stopping therapy

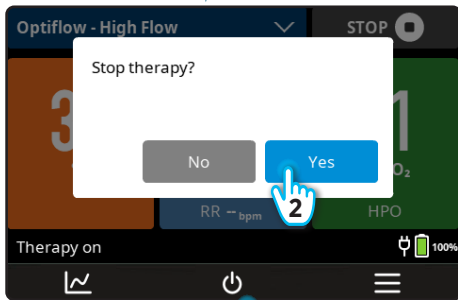
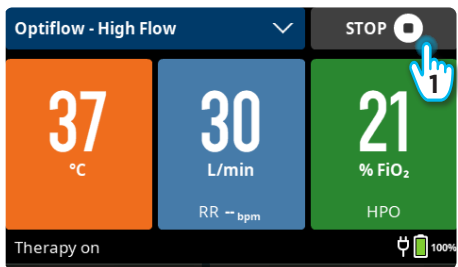

When therapy is finished:

1. Remove the patient interface from your patient.
2. If oxygen is provided through the low-pressure oxygen inlet port on the top of the Airvo 3, turn off and disconnect the oxygen supply.

Note

The Airvo 3 will automatically stop oxygen provided through the high-pressure oxygen inlet port. You do not need to disconnect it.

1. Tap the STOP button to end therapy.
2. Review any warnings, then tap Yes to confirm and enter standby mode or No to continue therapy.
3. Turn the Airvo 3 off by holding down the Power button for 2 seconds.
4. Tap Yes to power down the device.

The Airvo 3 must be cleaned and disinfected between patients. Follow the reprocessing instructions if your patient has finished using the device.

Warning

To avoid burns, do not touch the heater-plate or the bottom of the water chamber. The water in the chamber and the heater-plate beneath the chamber become hot during use.

Turn off the low-pressure oxygen source before stopping therapy. The oxygen flow must be turned off when the Airvo 3 is not delivering therapy to ensure oxygen does not build up inside the device.

6. Monitoring data

Warning

The Airvo 3 does not replace a vital signs monitor. A separate and dedicated monitoring device must be used if such monitoring is required.

The Airvo 3 records up to 24 hours of data for review on the Data and Graphs screen, accessible by tapping the Data and Graphs information button  from the Home screen. Data and Graphs data will be lost if power from the battery and from the wall power supply is lost. Refer to the Airvo 3 Technical Manual for detailed information on data handling.

The Airvo 3 is designed not to collect identifiable information about end-users. To function effectively, Airvo 3 will collect and store limited therapy data.

Limited Airvo 3 device information may be collected by F&P to monitor medical device performance, including device identifiers. This is to monitor medical device effectiveness, and improvement opportunities (e.g. firmware). Information is stored and used securely by F&P and does not include any data relating to your patient's personal information.

For more information about what type data is involved in these activities, refer to the Airvo 3 Technical Manual.

Please refer to the T&Cs for your data protection and privacy obligations. Alternatively, refer our Global Privacy Statement on our website for more on how we handle personal information.

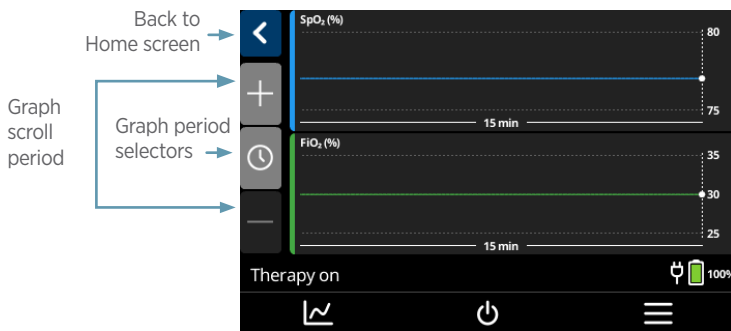

The graph selector screen shows all of the available graphs for the therapy. A graph can be accessed by pressing on a tile. Graphs can alternatively be selected using the scroll button outside of the graph selector screen.

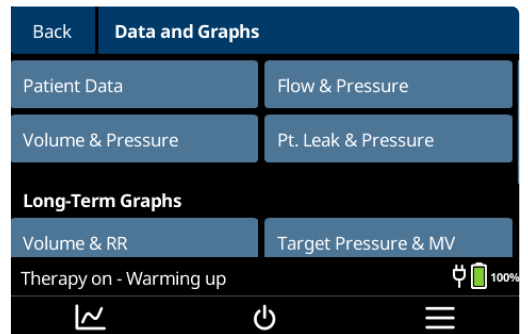

6.1 Patient Data

The values displayed in the Patient Data screen are described below. Measurements that are not available are shown as "--". Measurements may not be available when the Airvo 3 is in standby mode or the device has not collected enough data for a reliable measurement.

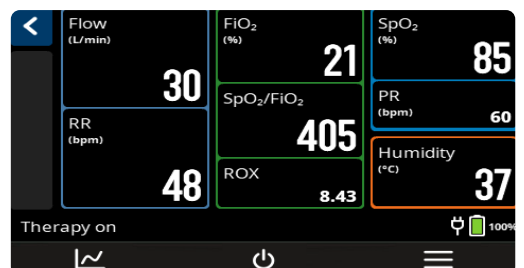

Label	Unit	Description
Flow	L/min	The current flow rate of breathing gases supplied to the patient
RR	BPM	The patient's respiratory rate (breaths/minute), averaged over the last 90 seconds
Temp	°C	The current temperature of breathing gases supplied to the patient
FiO ₂	%	The current fraction of oxygen in breathing gases supplied to the patient
SpO ₂ /FiO ₂		Ratio of SpO ₂ and FiO ₂
ROX		SpO ₂ divided by FiO ₂ and respiratory rate
SpO ₂	%	Peripheral blood oxygen saturation measured by pulse oximeter
PR	BPM	Pulse rate measured by pulse oximeter

6.2 Live value graphs

Airvo 3 live value trends graphs show the last 30 seconds of data

Label	Unit	Description
Flow	L/min	The current flow rate of breathing gases supplied to the patient

6.3 Long term graphs

Airvo 3 Data and Graphs show measurements plotted against time for up to 24 hours. New measurements are added to the right side of the graph. Prior data will scroll to the left as new measurements are added. Gaps will appear in the plotted data if therapy is stopped or measurements are missing due to poor signal quality.

The graphs available are described in the table below.

Label	Unit	Description
Target flow	L/min	The target flow rate of breathing gases supplied to the patient
RR	BPM	The patient's respiratory rate (breaths/minute), averaged over the last 90 seconds
FiO ₂	%	The fraction of oxygen in breathing gases supplied to the patient
SpO ₂ /FiO ₂		Ratio of SpO ₂ and FiO ₂
ROX		SpO ₂ divided by FiO ₂ and respiratory rate
SpO ₂	%	Peripheral blood oxygen saturation measured by pulse oximeter
PR	BPM	Pulse rate measured by pulse oximeter

7. Troubleshooting

This section describes common causes, and solutions to, problems and alarms that you may encounter while using the Airvo 3. The Airvo 3 Technical Manual contains additional information that may be helpful in resolving more advanced problems.

7.1 Alarms

The Airvo 3 has visual and auditory alarms to notify users about interruptions to a patient's treatment. These alarms are generated by an intelligent alarm system, which processes information from sensors and target settings of the device and compares this information with pre-programmed limits. Changes to alarm settings will be preserved during or after any power loss.

The signal light flashes and troubleshooting information is displayed on the Airvo 3 touch screen when any alarm is active. The color of the signal light indicates the highest-priority active alarm condition.



7.2 Alarm priority

Alarms are grouped by urgency and severity into three priority levels: low, medium, high. When multiple alarms are active, the audible alert, signal light and Message bar background color signal the highest-priority alarm active.

- A response is needed for all alarms.
- A prompt response is required for all medium-priority alarms.
- An immediate response is required for all high-priority alarms.

Priority	Message bar, signal light color	Audible alert
Low	Solid yellow	High then low-pitched beep
Medium	Flashing yellow	3 beeps every 9 seconds
High	Flashing red	3 high then 2 low-pitched beeps every 5 seconds

Warning

Audible alarms may not be heard if the alarm volume is set lower than ambient noise. Missed alarms may lead to patient injury. Refer to the Airvo 3 Technical Manual to review and set the alarm volume.



7.3 Auditory information signals

The informative sounds made by the Airvo 3 are:

Melody	Meaning
Ascending sequence of 5 tones	The breathing gas has reached the target settings.
Single tone	A touch on the display has been registered.
Single low then high tone	All active alarms have been resolved.
High note followed by 2 (identical) lower notes, repeated every 10 seconds	The wall power supply has been disconnected or turned off and the (optional) battery is depleted.
Descending sequence of 3 tones	The device has completed the power off process.
Sequence of 3 tones with high, low then middle pitch	The device has been turned on.

7.4 Viewing alarm details

Alarms are displayed with suggestions and action buttons for managing the alarm information:

- Tap the Audio Pause button to silence the alarm for 120 seconds. The Audio Pause button will change to  when audible alarms are silenced.
- Use   to scroll through multiple suggestions. Some alarms have only one suggested resolution.
- Tap Hide suggestions to collapse the alarm information to the Message bar. Restore suggestions by tapping the alarm condition on the Message bar.

The alarm condition and action button are displayed on the Message bar when alarm information is collapsed.

The Message bar cycles through each alarm condition when multiple alarms are active. Tapping the Message bar displays a list of active alarm conditions, from highest priority to lowest priority and they are ordered from when they occurred.

Alarm signals always indicate the highest-priority active alarm condition.

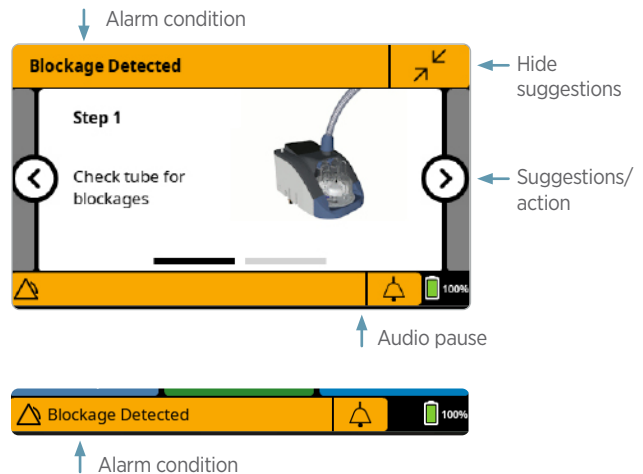

Action buttons

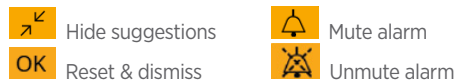

7.5 Checking the alarm system

To test the alarm system:

1. In standby mode, disconnect the breathing tube then press "Start".
2. Verify that the "Check tube" visual alarm appears on screen.
3. Verify that the signal light flashes yellow.
4. Verify that the auditory alarm signal can be heard.

Do not use the Airvo 3 if it fails this test. Contact your Fisher & Paykel Healthcare representative.

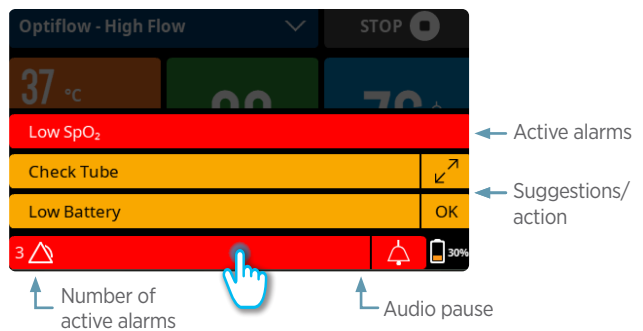

7.6 Airvo 3 alarms

All the alarms you may encounter while using the Airvo 3 are listed below with common causes, resolutions and any delays inherent in determining alarm conditions. These priorities have been allocated for an intended operator's position of 2 meters from the device. The Airvo 3 also uses an internal-priority ranking system. If multiple alarm conditions occur simultaneously, the device will display the highest-priority alarm.

Alarm condition	Priority	Delay	Meaning
Faults			
Device Fault [Error Code]	High	-	A technical fault has occurred that has caused therapy to be stopped. Restart the device to resolve the fault. If the issue persists, contact your service representative.
Device Fault [Error Code]	Med.	-	A technical fault has occurred, and the device is able to continue supplying limited therapy. Restart the device to resolve the fault. If the issue persists, contact your service representative.
Power alarms			
Power Out	High	< 5 s	The Airvo 3 has been disconnected from the AC power supply and the internal battery is depleted. The auditory alarm will sound once every 10 seconds for 120 seconds and the signal light above the touch screen will flash. The touch screen is off during the Power Out alarm. The Airvo 3 will shut down after signaling the Power Out alarm but will restart automatically if power is restored before it shuts down.

Alarm condition	Priority	Delay	Meaning
Unsupported Battery	Med.	< 5 s	The device is running off the battery and either an incorrect battery type is connected or communications with the battery could not be established.
Critically Low Battery	Med.	< 5 s	The Airvo 3 battery level is critically low. Connect the Airvo 3 to a wall power supply immediately to maintain therapy.
Low Battery	Low	< 5 s	The Airvo 3 battery level is low and should be connected to a wall power supply. Therapy continues as normal.
Battery Mode: Reduced Humidity	Low	< 5 s	The Airvo 3 has been disconnected from the AC power supply and the device is now running off the battery. The delivered humidity may be reduced.
Battery Charger Fault	Low	< 30 s	The battery charger is not functioning correctly and has been disabled. Restart the device to resolve the fault. If the issue persists, contact your service representative.
Therapy alarm - tube			
Outlet Elbow Missing	High	< 15 s	The Airvo 3 outlet elbow has been removed from the device during therapy. Check that the outlet elbow is fully inserted into the Airvo 3. If the issue persists, replace the outlet elbow.
Check Tube	Med.	< 5 s	The Airvo 3 cannot detect the heated breathing tube. Check that the heated breathing tube is not damaged and is plugged in correctly. Replace the heated breathing tube if the problem persists.
Wrong Tube	Med.	< 5 s	The heated breathing tube is not suitable for the selected therapy, or is faulty. Connect a suitable heated breathing tube. Replace the breathing tube if the problem persists.
Outlet Elbow Fault	Med.	< 5 s	A fault has been detected with the outlet elbow. Check that the outlet elbow is fully inserted into the Airvo 3. If the issue persists, replace the outlet elbow.
Outlet Elbow Too Warm	Med.	< 5 s	The outlet elbow is too warm to run start up checks. Wait for the outlet elbow to cool down. If the issue persists, replace the outlet elbow.
Therapy alarm – high flow			
Chamber Leak Detected	Med.	< 30 s	The water chamber has been removed. Ensure the water chamber is correctly inserted into the Airvo 3. If the issue persists, contact your service representative.
Leak Detected	Med.	< 30 s	The Airvo 3 has detected a leak in the breathing circuit. Check: <ul style="list-style-type: none"> • The water chamber has not been removed and is properly installed, • The heated breathing tube is plugged in correctly or is not damaged, • The patient interface is fitted correctly, and • The air filter is fitted correctly.
Blockage Detected	Med.	< 15 s	The Airvo 3 has detected a blockage. Check: <ul style="list-style-type: none"> • For blockages in the heated breathing tube, patient interface and inlet air filter, • The patient interface is the correct size for the patient, and • The target flow rate is within the rated range of the interface. If the issue persists, replace the consumables.
Flow Below Target	Med.	< 2 min	The Airvo 3 cannot reach the target flow rate. Check: <ul style="list-style-type: none"> • For blockages in the heated breathing tube, patient interface and inlet air filter, • The patient interface is the correct size for the patient, and • The target flow rate is within the rated range of the interface. If the issue persists, replace the consumables.

Alarm condition	Priority	Delay	Meaning
Flow Above Target	Low	< 2 min	<p>The Airvo 3 flow rate is higher than the target flow rate. Check:</p> <ul style="list-style-type: none"> • For leaks in the water chamber, heated breathing tube and patient interface, • The inlet air filter is inserted correctly, and • The target flow rate is within the rated range of the interface. <p>If the issue persists, replace the consumables.</p>
Therapy alarm – other			
Target Flow Too High	Med.	< 60 s	<p>The Airvo 3 has exceeded an internal temperature limit. Continued operation at the current settings may result in a device fault and reduced therapy. Check the target flow rate is within the rated range of the interface, and adjust settings if appropriate. This alarm will resolve when the internal temperature is within the expected range.</p>
Check Water	Med.	< 30 min	<p>The water chamber has run out of water. Replace the chamber and water bag to resume normal operation. Ensure that the water chamber and/or water bag are not allowed to run out of water to ensure continuous humidification of the breathing gases.</p>
Humidity Below Target	Low	< 30 min	<p>The Airvo 3 cannot reach the target humidity. Check the water chamber contains water. Consider reducing the target humidity or flow rate, if appropriate. If the issue persists, replace the water chamber.</p>
Check Operating Conditions	Low	< 1 min	<p>The Airvo 3 has detected ambient conditions that are not suitable. Do not use the Airvo 3 when the ambient temperature is below 18 °C or above 28 °C. Move the device to a suitable environment.</p>
Disinfection alarms			
Disinfection failed to hold temperature	Med.	< 2 min	<p>The Airvo 3 cannot heat up to the required disinfection temperature. Check:</p> <ul style="list-style-type: none"> • The disinfection tube blue connector is connected to the top of the outlet elbow, • The disinfection tube red end is connected to the left hand chamber port, • The disinfection filter is connected to the right hand chamber port, <p>Then restart the device. If the problem is not resolved, replace the disinfection tube and outlet elbow in turn. If the issue persists, contact your service representative.</p>
Over temperature detected	Med	<5 s	<p>The Airvo 3 detected higher than expected temperatures during the disinfection cycle. Check:</p> <ul style="list-style-type: none"> • The disinfection tube blue connector is connected to the top of the outlet elbow, • The disinfection tube red end is connected to the left hand chamber port, • The disinfection filter is connected to the right hand chamber port, <p>Then restart the device. If the problem is not resolved, replace the disinfection tube and outlet elbow in turn. If the issue persists, contact your service representative.</p>
Check tube	Med.	<5 s	<p>The Airvo 3 cannot detect the disinfection tube. Check that the disinfection tube is not damaged and is plugged in correctly, then restart the device. If the problem is not resolved, replace the disinfection tube and outlet elbow in turn. If the issue persists, contact your service representative.</p>

Alarm condition	Priority	Delay	Meaning
Leak detected	Med.	<35 s	The Airvo 3 has detected a leak in the disinfection circuit. Check: <ul style="list-style-type: none"> The disinfection tube blue connector is connected to the top of the outlet elbow, The disinfection tube red end is connected to the left hand chamber port, The disinfection filter is connected to the right hand chamber port, Then restart the device. If the problem is not resolved, replace the disinfection tube and outlet elbow in turn. If the issue persists, contact your service representative.
Blockage detected	Med	<10 s	The Airvo 3 has detected a blockage. Check that the disinfection tube is not blocked and that the disinfection filter is not wet, then restart the device. If the problem is not resolved, replace the disinfection tube and outlet elbow in turn. If the issue persists, contact your service representative.
Check operating conditions	Med.	< 1 min	The Airvo 3 has detected ambient conditions that are not suitable. Do not use the Airvo 3 when the ambient temperature is below 18 °C or above 28 °C. Move the device to a suitable environment, then restart the device. If the issue persists, contact your service representative.
Wall Power Disconnected	Med.	< 5 s	The power cable has been removed and device is unable to perform a disinfection cycle. Connect device to wall power, then restart the device. If the issue persists, contact your service representative.
Unexpected O2	Med.	< 1 min	Oxygen is being supplied to the Airvo 3 while in disinfection mode. Check no oxygen is connected, then restart the device. If the issue persists, contact your service representative.
Oxygen alarms			
No O₂ Pressure at HPO Port	Med.	< 5 s	There is no oxygen being supplied to the high-pressure (HPO) inlet port during therapy. Check that the oxygen supply is working. If using an oxygen bottle, check the bottle is not empty. If switching to the low-pressure (LPO) inlet port or stopping oxygen delivery, set the FiO ₂ target to 21 %.
FiO₂ Below 25%	Med.	< 30 s	The oxygen being supplied to the LPO port has fallen below detectable levels during therapy. The oxygen supply may have been disconnected.
FiO₂ Below Target	Med.	< 2 min	Oxygen concentration cannot reach the FiO ₂ target. Check the oxygen supply is properly connected to the HPO inlet port and there are no leaks at any oxygen hose connections. Make sure the number of connected devices does not exceed the capacity of the oxygen supply. Consider using the LPO connection if the oxygen supply has insufficient capacity.
FiO₂ Above Target	Med.	< 2 min	The oxygen concentration being delivered is higher than the FiO ₂ target setting. Check an oxygen supply is not connected to the low-pressure oxygen inlet port. Only one oxygen source should be used at a time. Check the oxygen supply is properly connected to the high-pressure oxygen inlet port and that there are no leaks at the oxygen hose connections.
High FiO₂ (LPO)	Med.	< 20 s	FiO ₂ supplied by the LPO port is above the selected High Oxygen Alarm threshold for its intended clinical environment (range 30-95% or Off, default: 95%, see Airvo 3 Technical Manual). Check FiO ₂ is appropriate for the patient's condition. Reduce FiO ₂ to normal range when it is appropriate to do so.
Unexpected O₂	Med.	< 15 min	Oxygen is being supplied to the Airvo 3 while in standby. Check all oxygen supplies are turned off and disconnected. If the issue persists, contact your service representative.
High FiO₂ (HPO)	Low	< 5 s	The FiO ₂ target is above the selected High Oxygen Alarm threshold for its intended clinical environment (range 30-95% or Off, default: 95%, see Airvo 3 Technical Manual). Check FiO ₂ is appropriate for the patient's condition. Reduce FiO ₂ to normal range when it is appropriate to do so.
Pulse oximetry alarms			
Pulse Ox Disconnected	Med.	< 1 s	The pulse oximetry accessories have become disconnected. Reconnect pulse oximetry accessories.

Alarm condition	Priority	Delay	Meaning
Pulse Ox Communication Failure	Med.	< 10 s	Unable to communicate with the pulse oximeter. Check that the USB connector cable, sensor adapter cable and sensor cables are all properly connected. Replace the sensor cable, adapter cable then USB connector cable in turn if the problem persists.
No Pulse Ox Sensor Connected	Med.	< 1 s	A pulse oximetry sensor cable was not detected or is inoperable. Check that the sensor cable is properly connected to the USB connector cable or replace the sensor cable if necessary.
Pulse Ox Sensor Off Patient	Med.	< 1 s	The pulse oximeter is no longer receiving SpO ₂ measurements from the patient. Check that the sensor is properly attached to a suitable measurement site on the patient.
No SpO₂ Reading	Med.	< 16 s	The pulse oximeter is not sending valid SpO ₂ measurements. Check the sensor, cable and USB interface. Try replacing each component in turn until the problem is resolved.
No Pulse Rate Reading	Med.	< 16 s	The pulse oximeter is not sending valid Pulse Rate measurements. Check the sensor, cable and USB interface. Try replacing each component in turn until the problem is resolved.
Pulse Ox Not Recognized	Med.	< 10 s	The selected oximeter has not been recognised. Please remove or change oximeter.
Physiological alarms			
Low SpO₂	High	< 15 s	Check your patient. The SpO ₂ measurement has decreased below the Low SpO ₂ alarm threshold. Check that the alarm setting is appropriate for your patient (Range: 2-98%, default 85%).
High SpO₂	Med.	< 15 s	Check your patient. The SpO ₂ measurement has exceeded the High SpO ₂ alarm threshold. Check that the alarm setting is appropriate for your patient (Range: 2-99% or Off, default Off).

7.7 Pulse oximetry

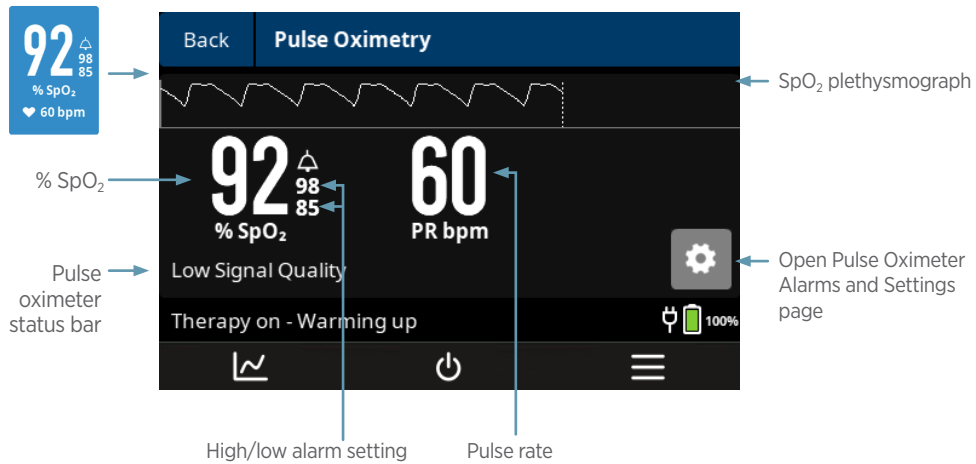

To help ensure successful monitoring of your patient's SpO₂:

- Apply the pulse oximeter sensor to a well-perfused site.
- Select a measurement site that has unrestricted blood flow.
- Follow all the instructions supplied with the pulse oximetry sensor to ensure the device is correctly applied.

The Pulse oximeter status bar displays the status of the pulse oximeter. Tap the Pulse oximeter tile to open the Pulse Oximetry screen and view the status. Possible status messages and warnings are described below.

Message	Cause/remedy
Low Signal Quality	<p>Indicates poor signal quality (signal inadequacy) and low confidence in the pulse oximeter measurements displayed. Measurements are drawn in gray on the pulse oximeter tile when signal quality is low. Low Signal Quality may be caused by excess motion, low perfusion, a long/blocked light path, or a damaged or incorrectly fitted sensor.</p> <ul style="list-style-type: none"> • Follow the sensor's user instructions to check it is the correct type and that it has been correctly applied to the patient. • Reduce or eliminate motion at the monitoring site. • Consider an adhesive sensor. • Check that the sensor's emitter and detector are properly aligned, particularly when using an adhesive sensor. • Consider a different measurement site. • Check that blood flow to the measurement site is not restricted. • See the pulse oximetry section for physiological conditions that may affect pulse oximetry measurement accuracy and consider an alternative method if indicated. • Remove excessive fingernail polish or artificial nails. • Replace the sensor.
Patient Missing	<p>The pulse oximeter cannot detect a patient. Check that the sensor is properly fitted by following the user instructions supplied with the sensor.</p>

If pulse oximeter measurements do not correlate with clinical assessment and/or arterial blood gas measurements:

- check the pulse oximeter status, as described above,
- check the pulse oximeter sensor is fitted correctly, following the user instructions supplied with the sensor,
- review the pulse oximetry section for conditions that may affect pulse oximetry measurement accuracy and consider an alternative method if indicated, and/or
- try a different measurement site.

8. Reprocessing

Standard aseptic techniques should be followed to minimize contamination when handling the Airvo 3 and accessories. The patient interface, heated breathing tube, water chamber and outlet elbow may become contaminated during use. As soon as possible after using the Airvo 3:

1. Remove the single-use accessories from the Airvo 3 and dispose of them in accordance with local laws, regulations and hospital protocols for disposing of contaminated products.
 - Squeeze the sides of the breathing tube connector and lift to remove it from the Airvo 3.
 - Grip the port adapter and pull the water chamber away from the Airvo 3 to remove it.

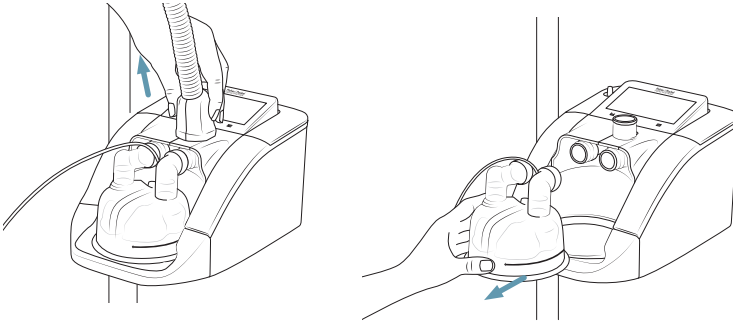

2. Reprocess the Airvo 3 device exterior by following the instructions in section 8.1
3. Clean and high-level disinfect the Outlet Elbow by following the instructions in section 8.2.
4. Replace accessories within the maximum use period shown in section 8.3 (schedule for changing accessories).
5. Clean and disinfect pulse oximetry accessories (including reusable sensors) in accordance with the manufacturer's instructions.

Warnings

Do not clean and/or disinfect the Airvo 3 while it is being used by a patient.
Do not submerge the Airvo 3 or accessories in any cleaning solution or attempt to sterilize by autoclave, irradiation, steam, gas, ethylene oxide or any other method. This will seriously damage the device.

8.1 Airvo 3 device exterior reprocessing

8.1.1 Clean

Equipment

- Mild detergent
- Clean, disposable, lint-free cloths
- Protective gloves

Cleaning Instructions

1. Mix a solution of warm water and mild detergent (refer to the detergent manufacturer's instructions for use).
2. Dampen a clean cloth with the cleaning solution.
3. Thoroughly wipe all outside surfaces of the device (including the Outlet Elbow) for at least one minute to remove any visible soil. Use the corner/edge of the cloth to clean all crevices of the device.

Rinse

4. Dampen a clean cloth with tap water.
5. Thoroughly wipe all outside surfaces of the device with the damp cloth to remove any detergent residue.

Dry

6. Thoroughly wipe all outside surfaces of the device with a dry cloth until it is visibly dry.
7. Allow to air dry until completely dry.

8.1.2 Disinfect

Perform disinfection only after all cleaning steps are complete

Equipment

- Disinfectant wipes
- Clean, disposable, lint-free cloths
- Protective gloves

Disinfection Instructions

1. Use pre-soaked disinfecting wipes, to thoroughly wipe all outside surfaces of the device (including the Outlet Elbow).
2. Ensure that these surfaces remain visibly wet as directed by the manufacturer of the disinfecting wipes. Use additional wipes as needed to ensure that these surfaces remain wet for the required length of time.

Rinse

3. Dampen a clean cloth with tap water.
4. Thoroughly wipe all outside surfaces of the device with the damp cloth to remove any detergent residue.

Dry

5. Thoroughly wipe all outside surfaces of the device with a dry cloth until it is visibly dry.
6. Allow to air dry until completely dry.

Warnings

Other cleaning agents may be used if they are: non-abrasive, non-toxic, and non-corrosive. Do not use any cleaning agents that are not compatible with polycarbonate plastic.

Cleaning agents that are not suitable for use with the Airvo 3 include: ammonia, ammonium hydroxide, caustic soda, iodine, methanol, methylated spirits, turpentine, and alkaline bleaches such as sodium hypochlorite. The use of any of these products will damage the Airvo 3.

Turn off and disconnect the Airvo 3 from the wall power supply before cleaning to reduce the risk of electric shock.

Do not submerge the device in liquid of any kind.

Do not spray liquid directly onto the device.

These instructions have been validated by the manufacturer of the medical device as being capable of preparing a medical device for reuse. It remains the responsibility of the processor to ensure that the processing achieves the desired results, by using the correct equipment, materials, and personnel in the processing facility. This requires routine monitoring of the process.

8.2 Outlet elbow reprocessing

The Outlet Elbow requires cleaning and high-level disinfection. The Outlet Elbow can be reprocessed in two different ways:

- Disinfection Kit 900PT600 (see instructions in 900PT600)
- Washer-Disinfector (follow below instructions)

The outlet elbow can be removed from the Airvo 3 for reprocessing by your central sterile services or reprocessing department. Reprocessing the outlet elbow must be performed in a washer-disinfector that complies with and is maintained, checked and validated to ANSI/AAMI ST15883-1:2009 (USA) and ISO 15883-1:2006 (outside USA).

Disassembly

Remove the outlet elbow from the Airvo 3. Firmly grab the rubber port-seal on the outlet elbow, push down on the grip lines with your thumb and pull the outlet elbow towards the front of the Airvo 3.

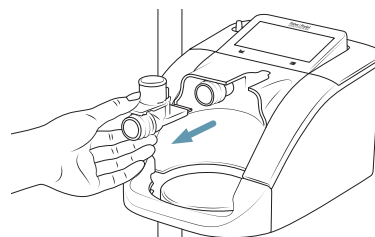

Transportation

Follow hospital infection control protocols to package the outlet elbow for transport. Protect the outlet elbow from mechanical damage during transport.

Using the storage cover

It is important that the Airvo 3 is stored properly after reprocessing. Store the Airvo 3 in a clean, dry and dust-free location that is suitable for medical devices.

Cover the Airvo 3 with the storage cover so that it remains clean during storage:

- Wrap the Airvo 3 in a storage cover (900PT603) so that the identification label on the cover sits prominently above the display of the Airvo 3.
- Seal the cover with the adhesive tabs on the storage cover.

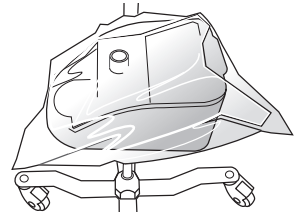

Cleaning and disinfection

Washer-disinfector supplies required for reprocessing of the Airvo 3 outlet elbow are:

Warnings

Other cleaning agents may be used if they are: non-abrasive, non-toxic and non-corrosive. Do not use any cleaning agents that are not compatible with polycarbonate plastic.

Cleaning agents that are not suitable for use with the Airvo 3 include: ammonia, ammonium hydroxide, caustic soda, iodine, methanol, methylated spirits, turpentine and alkaline bleaches such as sodium hypochlorite. Use of any of these products will damage the Airvo 3.

Do not use rinse aids as these may cause damage to the outlet elbow.

Place the outlet elbow in a washer-disinfector and orient the outlet elbow such that washing fluid can contact all internal surfaces and allow for draining. Run a cleaning and thermal high-level disinfection cycle:

- Pre-cleaning: Cold rinse for at least 1 minute
- Cleaning: Wash at 55 °C for at least 5 minutes with a mildly alkaline cleaning agent as per manufacturer's instructions (e.g. neodisher® MediClean forte, 0.2 % v/v)
- Neutralisation: Cold rinse for at least 1 minute
- Rinsing: Cold rinse for at least 1 minute
- Thermal disinfection: 90 °C for 5 minutes
- Drying: 90 °C for 25 minute

Note

Do not exceed the maximum use period for the outlet elbow.

Follow the manufacturer's instructions and warnings for all cleaning products.

Visual inspection

Visually inspect the outlet elbow for mechanical damage or discoloration of the chamber seal. If the seal or elbow appear damaged or discolored, replace the outlet elbow.

Warning

Do not use the outlet elbow if the seal or elbow appear damaged or discolored. A damaged outlet elbow may affect therapy delivery.

Storage and transport

It is important that the outlet elbow is stored properly after reprocessing. Store the outlet elbow in a clean, sealed plastic bag labeled with the disinfection process details. Follow your hospital protocol for storage of high-level disinfected devices. Protect the outlet elbow from mechanical damage during transport. Store the outlet elbow in a clean, dry and dust-free location that is suitable for medical devices. The outlet elbow can alternatively be inserted back into the Airvo 3 then covered with the storage cover until the next use.

Reassembly

When setting up the Airvo 3 for the next use follow the reassembly steps below. If reassembly occurs prior to the next use, cover the Airvo 3 with the outlet elbow assembled with the clean storage cover.

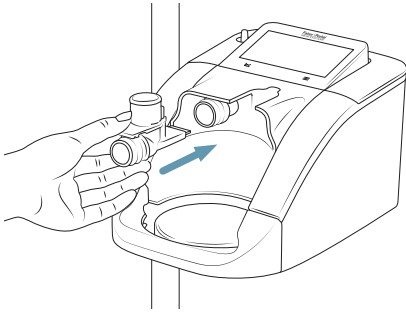

Slide the disinfected outlet elbow into the slot above the chamber area on the Airvo 3.

Push firmly on the front of the elbow until the elbow locks into place.

⚠ Note

Make sure the outlet elbow is installed in the Airvo 3 before attaching the heated breathing tube.

8.3 Schedule for changing accessories

The Airvo 3 accessories must be changed according to the schedule below. All single-patient-use accessories must be disposed of after the patient's therapy to prevent cross-contamination. Replace accessories within the period shown below, or immediately if they are damaged or discolored.

Accessory	Maximum use
Optiflow Junior interfaces	1 week, or 1 patient (whichever comes first)
Optiflow+ interfaces Optiflow 3S interfaces All AirSpiral tube and chamber kits	14 days (7 days when using a nebulizer), or 1 patient (whichever comes first)
Air filter	3 months or 1000 hours use (whichever comes first)
Outlet elbow	5 years or 50 washer-disinfector cycles (whichever comes first)
Battery*	2 years or 300 discharge cycles (whichever comes first)
Pulse oximetry accessories	Refer to instructions for use supplied with device.

* See Airvo 3 Technical Manual for instructions to change the battery.

8.4 Replacing the air filter

The Airvo 3 will display a message when the air filter is due to be replaced.

Begin by removing the old filter:

1. Raise the filter cover.
2. Push the filter removal tool down firmly onto the low-pressure oxygen inlet port to get the removal tool to grip.
3. Hold down the air-filter release button.
4. Pull up on the filter removal tool to remove the filter.

Insert the new filter, pushing down on top of the filter until it clicks into place.

Lower the filter cover.

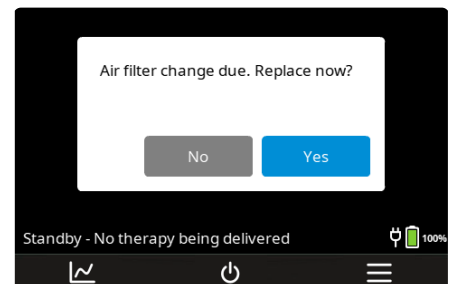
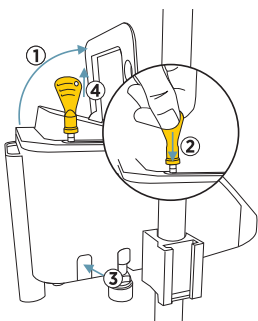

8.5 Servicing

The Airvo 3 does not require regular maintenance and contains no user serviceable parts. If the Medical Equipment system is modified from the specification of the manufacturer, evaluation to the requirements of 60601-1 standard is required. Refer to the Airvo 3 Technical Manual for product acceptance checks, functional tests and spare parts. Contact your Fisher & Paykel Healthcare representative if a fault develops or you are concerned the Airvo 3 is not operating correctly.

9. Pulse oximetry

When compatible pulse oximetry accessories are connected, the Airvo 3 can display:

- functional oxygen saturation (SpO₂),
- pulse rate (no pulse rate alarms are provided),
- plethysmograph, and
- signal quality indicators.

9.1 Description of measurements

Pulse oximetry measurements are displayed on the Pulse Oximetry tile, the Pulse Oximetry screen and the Data and Graphs screen. Measurements are updated every second.

Tap the Pulse Oximetry tile to open the Pulse Oximetry screen and  to open the Data and Graphs screen.

Tapping  on the Pulse Oximetry screen provides a shortcut to the pulse oximetry alarms and settings.

Caution

If any measurement seems questionable, check the patient's vital signs by another method. Then check the pulse oximetry accessories and Airvo 3 are set up, configured and working correctly.

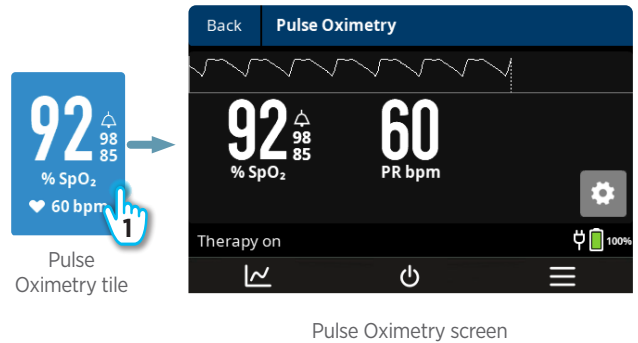

Pulse Oximetry screen

9.1.1 SpO₂

The Airvo 3 is calibrated to display functional oxygen saturation (SpO₂) as a percentage. The SpO₂ value displayed is an average of measurements over a user selectable period (see Averaging Time in section 9.3 below). A long averaging period will generally produce more stable values but the SpO₂ displayed will respond more slowly to rapid changes in arterial blood oxygen saturation (SaO₂).

Stability of the SpO₂ measurements displayed may provide a good indication of a valid signal. Though stability is a relative term, experience with the device and patient observations will help you separate physiological effects from artifacts caused by a poorly-placed sensor or excess patient motion.

Inconsistencies between SpO₂ displayed on the Airvo 3 and arterial blood gas analysis or clinical assessment may be caused by:

- poor signal quality,
- low perfusion,
- improperly-placed sensors or cables, and/or
- the patient's condition.

9.1.2 Pulse rate

Pulse rate (, PR) measurements are based on optical detection of pulsatile peripheral blood flow by the pulse oximeter sensor. The pulse rate displayed, in beats per minute (bpm), is an average of measurements over a user-selectable period.

Small differences in the pulse rate displayed by different equipment may be caused by different approaches to averaging. Small discrepancies between cardiac electrical

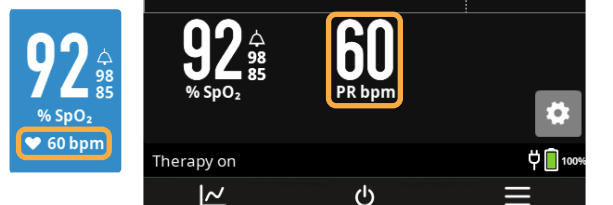
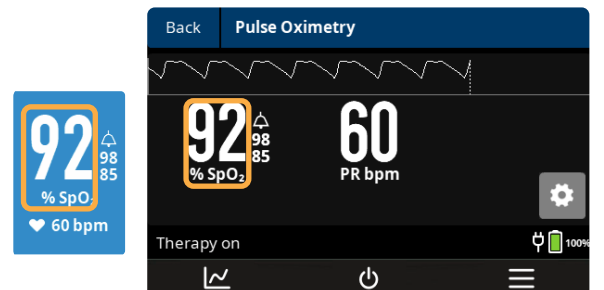

activity and pulse rate obtained from peripheral measurements can also arise. Large discrepancies between equipment may be caused by:

- poor signal quality,
- low perfusion,
- improperly placed sensors or cables, and/or
- the patient's condition.

9.1.3 Plethysmograph

A plethysmograph (or photo-plethysmograph) provides a non-normalized indication of the change in blood volume measured by the pulse oximeter sensor. The shape of the plethysmograph may change between patients, between measurement site and for different sensor models. Low amplitude or variable plethysmograph may indicate poor signal. The plethysmograph is displayed on the Pulse Oximetry screen.

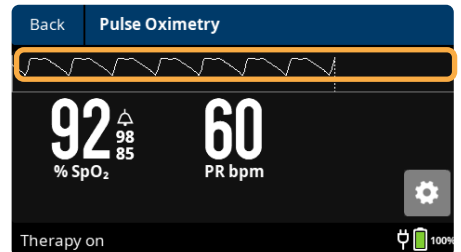

9.1.4 Signal quality indicators

Nonin:

Nonin pulse oximetry equipment indicate signal quality based on the perfusion of the patient. There are three states: green, yellow, and red corresponding to high, low/marginal, and low/poor signal quality respectively. During these periods of low signal quality (signal inadequacy) pulse oximetry values displayed may be incorrect. The Airvo 3 indicates low signal quality by greying out the SpO2 and Pulse rate numbers

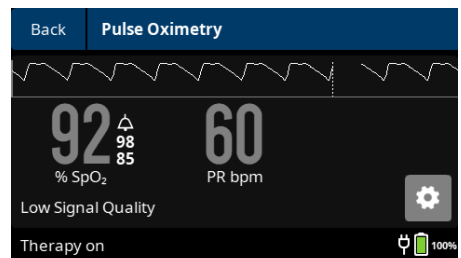

9.2 Description of settings and alarms

This section describes the behavior of pulse oximetry settings and alarms. See the Alarms and measurement section (9.3) on how to make changes to the alarm thresholds and settings.

9.2.1 Patient alarm thresholds

The following alarms can alert you to changes in your patient's condition:

- SpO₂ Low alarm
- SpO₂ High alarm

The corresponding alarm will be raised when a measurement is lower or higher than the alarm threshold.

SpO₂ alarm thresholds are displayed on the Pulse Oximeter tile and Pulse oximeter screen.

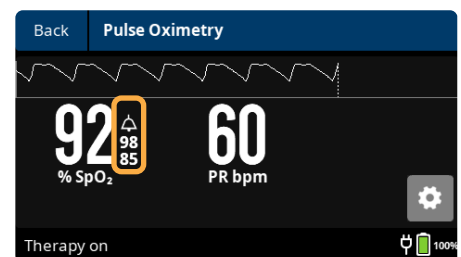

9.2.2 SpO₂ Alarm Delay

The SpO₂ Alarm Delay setting defers the audible Low SpO₂ and High SpO₂ alarms for up to 15 seconds. This delay helps reduce non-actionable alarms for short desaturations. The audible alarm will start, if the alarm condition remains, after the delay.

9.2.3 Alarm response time

Audible and visual alarms are subject to an alarm response delay. The alarm response delay has three parts, the:

1. Alarm condition delay: the duration for a physiological change to be recognized by pulse oximetry,
2. Alarm signal generation delay: the period between detecting a condition and signaling the alarm, and
3. Alarm reporting delay: the period between receiving an alarm signal from a monitoring device and reporting the alarm to the user.

Measurement averaging will affect the signal generation delay: a larger Averaging Time will increase the signal generation delay. These delay concepts are illustrated on the graph below for a decrease in SaO_2 leading to a SpO_2 Low alarm as an example. The illustration does not reflect the actual length of delays. Refer to ISO 80601-2-61 for more information about alarm response delays.

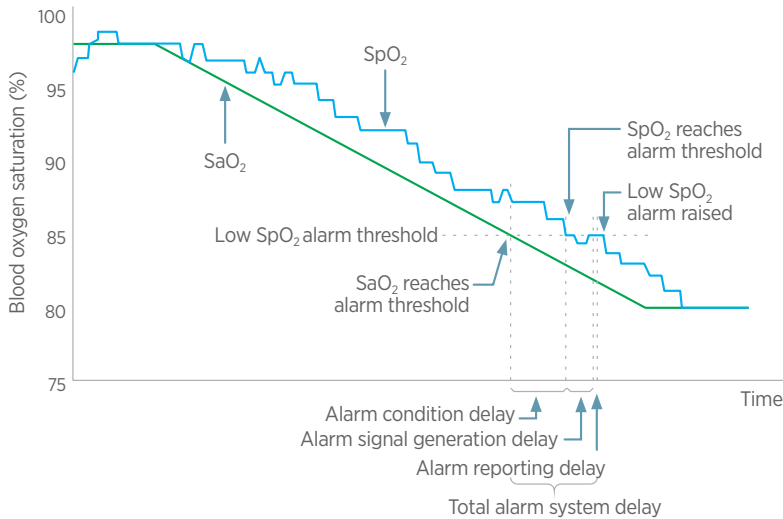

9.3 Alarm and measurement settings

To change pulse oximetry alarm thresholds and settings:

1. Tap to open the system menu,
2. Select Pulse Oximeter Alarms and Settings,
3. Tap the desired setting, scrolling if necessary,
4. Use the + / - buttons to select the required value,
5. Tap Confirm to apply the change or Cancel to discard any changes and return to the settings list.

Tap Back twice to return to the Home Screen when you have finished making changes.

All settings are persistent and will retain their previous value when the Airvo 3 is turned on and Same Patient is selected. Selecting New Patient when reviewing the disinfection state applies the default values for its intended clinical environment to all alarm and measurement settings.

Refer to the troubleshooting section for troubleshooting SpO_2 measurements and general device alarms.

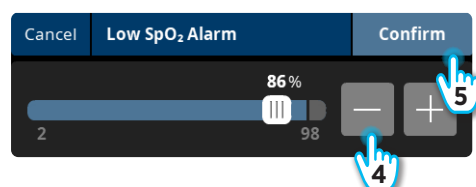
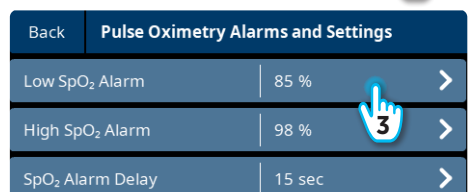
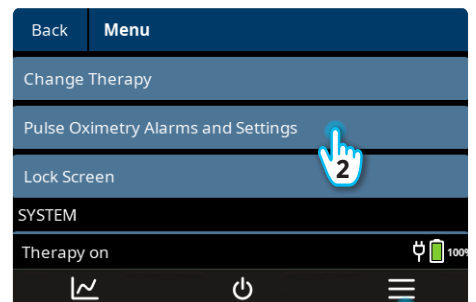

Label	Description	Factory default	Range
Low SpO₂ Alarm ^{1,2}	Threshold for SpO ₂ Low alarm	85%	1 – 98% ³
High SpO₂ Alarm ²	Threshold for SpO ₂ High alarm	Off	Off, 2 – 99% ³
SpO₂ Alarm Delay	Delay before audible Low SpO ₂ or High SpO ₂ alarm	15 seconds	0, 5, 10, 15 seconds
Averaging Time	The number of pulses to average over	8 beats	4 or 8 beats

¹ The minimum threshold may be set when the device is set up for its intended clinical environment. Refer to the Airvo 3 Technical Manual for details.

² The high alarm threshold cannot be set below the low alarm threshold.

³ The alarm threshold can be changed in 1% steps.

Warning

Using different alarm settings on devices within a single area, such as an intensive care unit, can cause a hazard.

Caution

Setting extreme alarm thresholds can render alarms useless and may lead to patient injury.

Specifications

General

Dimensions	205 mm x 295 mm x 190 mm
Weight (including battery)	4.45 kg
Supply voltage/current	100 – 115 VAC, 2.4 A (2.6 A max*) 220 – 240 VAC, 1.1 A (1.3 A max*)
Supply frequency	50 – 60 Hz
USB port sourcing (1 and 2)	5 V, 0.35 A (maximum each port)
Auditory alarm	
Sound pressure level	> 40 dBA @ 1 m
Audio pause duration	120 seconds
Sound level	< 50 dBA @ 1 m
Ingress protection	IP22 ²
Expected service life	5 years ³

Operating conditions

Ambient temperature	18 – 28 °C
Humidity	10 – 95% relative humidity (non-condensing)
Ambient pressure	700 – 1060 hPa
Altitude range	0 – 3000 m
Mode of operation	Continuous operation
Maximum surface temperature of applied parts⁴	44 °C
Maximum delivered dew-point temperature of respiratory gas⁴	43 °C

Storage and transport conditions

Ambient temperature^{5,6}	-10 – 50 °C
Humidity (non-condensing)	10 – 95% relative humidity

Battery (900PT957L)

Chemistry	Lithium Ion (Li-Ion)
Voltage	14.4 VDC
Capacity, Power output	99.4 Wh, 80 W
Battery life¹³	300 cycles or 2 years from the date of manufacture (whichever comes first)
Recharge time	6 hours (maximum)
Storage life	1 year
Operating time¹³	
Typical	40 minutes
Worst case⁷	20 minutes

Supplementary oxygen

Oxygen sensor startup time	< 30 s
Oxygen response time	< 60 s
High-pressure oxygen (HPO) inlet port	
Line pressure	280 – 600 kPa (40 – 87 psi)
Maximum flow rate (3 s & 10 s)	100 L/min (STPD ⁸)
Low-pressure oxygen (LPO) inlet port	
Line pressure	0-70 kPa (0-10 psi)
Maximum flow rate	60 L/min (STPD ⁸)

Optiflow high flow therapy⁹

Target humidity range	31 – 37 °C
Target flow range¹⁰	2 – 70 L/min
Maximum limited pressure¹²	60 cmH ₂ O
Oxygen concentration	21 – 100% FiO ₂
Humidity^{4,13}	
Wall power	> 33 mg/L at 37 °C target humidity, 10 – 60 L/min target flow > 12 mg/L for all other settings
Warm-up time¹¹ (MR290 chamber) 23 ± 2 °C to 37 °C	< 20 min

Communications

Bluetooth technology	2.402 – 2.480 Ghz Max. Power +20 dBm
Wifi	2.412 - 2.48 GHz/4.9 - 5.975 GHz

- Inrush current may reach 50 A.
- The device is protected against harmful effects of dripping water when tilted by up to 15° and/or incursion of fingers or similar-sized objects.
- Assumes typical usage pattern. Actual service life may vary.
- In accordance with ISO 80601-2-74. Tested to an accuracy of ± 1 °C or ± 1 mg/L, as appropriate.
- Storage at temperatures above 40 °C (104 °F) for prolonged periods will accelerate battery degradation.
- The device may require up to 24 hours to equilibrate to operating temperature before it is ready for use.
- Worst-case operating time applies to a fully charged battery at 25 °C that has experienced 300 charge/discharge cycles followed by 1 year of storage.
- Flow rate is expressed in STPD (standard temperature and pressure, dry) as per ISO 80601-2-74.
- Values are expressed in body temperature, pressure, saturated (BTPS), in accordance with ISO 80601-2-74, unless otherwise stated.
- Achievable flow range depends on the patient interface selected.
- Applies when the device is connected to a wall power supply for warm-up.
- In accordance with ISO 80601-2-90.
- For humidity performance under battery use, see Appendix 4.

Range and accuracy of measured parameters

Measurement	Symbol	Displayed Range	Accuracy
Humidity	Temp	31 – 37 °C	Not specified
Flow rate	Flow	2 – 70 L/min	± (1 + 5% of reading) L/min
Oxygen concentration*	FiO ₂	21 – 100%	Lower of: ± 4%, or ± (2.5% + 2.5% of reading) - excluding rounding to 21% and 100%, as appropriate - provided “Oxygen concentration” setting is correct
Respiratory rate	RR	4 – 70 BPM	RMS error of < 3 BPM**
Peripheral blood oxygen saturation	SpO ₂	1 – 100%	See Nonin pulse oximetry specifications below.
Pulse rate	PR / 	18 – 321 beats/min	See Nonin pulse oximetry specifications below.

* Oxygen measurements are automatically compensated for changes in barometric pressure.

** An RMS accuracy is a statistical calculation of the difference between device measurements and reference measurements. Approximately two-thirds of the device measurements fell within +/- ARMS of the reference measurements in a controlled study.

Pulse oximetry

Specifications are tabulated for the Airvo 3 and all compatible sensors unless otherwise stated.

Nonin:

Data update period	< 30 sec
---------------------------	----------

Measurement wavelengths and Output Power*	Red: 660 nanometers @ 0.8 mW max. avg. Infrared: 910 nanometers @ 1.2 mW max avg. (using Nonin Purelight® sensor)
--	--

SpO₂ Accuracy (A_{rms}™)	70 to 100%	
No Motion	Adults/Pediatrics***	Neonates
Reusable		
8000AX Series:	± 2 digits	N/A
800XJ Series:	± 3 digits	N/A
8000SX Series:	± 2 digits	N/A
8000R:	± 3 digits	N/A
8000Q2:	± 3 digits	N/A
Disposable		
6000CX Series:	± 2 digits	± 3 digits
7000X Series:	± 2 digits	± 3 digits
Motion		
Reusable		
8000AX Series:	± 2 digits	N/A
800XJ Series:	± 3 digits	N/A
8000SX Series:	± 3 digits	N/A
Low Perfusion****	± 2 digits	± 3 digits
Pulse Rate Accuracy		
No Motion (18 - 300 BPM)		
Reusable		
8000AX Series:	± 3 digits	N/A
800XJ Series:	± 3 digits	N/A
8000SX Series:	± 3 digits	N/A
8000R:	± 3 digits	N/A
8000Q2:	± 3 digits	N/A
Disposable		
6000CX Series:	± 3 digits	± 3 digits
7000X Series:	± 3 digits	± 3 digits
Motion (40 - 240 BPM)		
Reusable		
8000AX Series:	± 5 digits	N/A
800XJ Series:	± 5 digits	N/A
8000SX Series:	± 5 digits	N/A
Low Perfusion (40 - 240 BPM)****	± 3 digits	± 3 digits

* This information is especially useful for clinicians performing photodynamic therapy.

** ± 1 A_{rms} represents approximately 68% of measurements.

*** Includes Infant patients

**** Does not apply to those sensors listed as N/A under the neonate column, 8000R and 8000Q2

Notes:

- SpO₂ accuracy testing is conducted during induced hypoxia studies on healthy, non-smoking, light-to-dark-skinned subjects during motion and no-motion conditions in an independent research laboratory. The measured arterial hemoglobin saturation value (SpO₂) of the sensors is compared to arterial hemoglobin oxygen (SaO₂) value, determined from blood samples with a laboratory co-oximeter. The accuracy of the sensors in comparison to the co-oximeter samples measured over the SpO₂ range of 70 - 100%. Accuracy data is calculated using the root-mean-squared (Arms value) for all subjects, per ISO 80601-2-61 formerly ISO 9919, Standard Specification for Pulse Oximeters for Accuracy.
- Pulse rate motion testing measures pulse rate accuracy with motion artifact simulation introduced by a pulse oximeter tester. This test determines whether the oximeter meets the criteria of ISO 80601-2-61, formerly ISO 9919, for pulse rate during simulated movement, tremor, and spike motions.
- Low perfusion testing uses an SpO₂ Simulator to provide a simulated pulse rate, with adjustable amplitude settings at various SpO₂ levels. The module must maintain accuracy in accordance with ISO 80601-2-61, formerly ISO 9919, pulse rate and SpO₂ at the lowest obtainable pulse amplitude (0.3% modulation).

Standards compliance

Designed to conform to the following standards:
IEC 60601-1:2005 + A1:2012 (ed 3.1)
IEC 60601-1-2: 2014
IEC 60601-1-8:2006 + Amd 1 2012
ISO 80601-2-61: 2017
ISO 80601-2-74:2017

Do not place any part of the device or accessories within 30 cm (12") of any portable mobile radio frequency communication equipment. The Airvo 3 complies with the electromagnetic compatibility requirements of IEC 60601-1-2. In certain circumstances the Airvo 3 may affect or be affected by nearby equipment because of electromagnetic interference. Excessive electromagnetic interference may affect the therapy delivered by the device. If this should happen, try moving the Airvo 3 or the unit causing interference, or consult your healthcare provider.

FCC compliance

This device has been tested and found to comply with the limits for a Class B digital device, pursuant to part 15 of the FCC Rules. These limits are designed to provide reasonable protection against harmful interference in a residential installation. This device generates, uses, and can radiate radio frequency energy and, if not installed and used in accordance with the instructions, may cause harmful interference to radio communications. However, there is no guarantee that interference will not occur in a particular installation. If this device does cause harmful interference to radio or television reception, which can be determined by turning the device off and on, the user is encouraged to try to correct the interference by one or more of the following measures:

- Reposition or relocate the receiving antenna.
- Increase the separation between the device and receiver.
- Connect the device into an outlet on a circuit different from that to which the receiver is connected.
- Consult your healthcare provider or your Fisher & Paykel Healthcare representative for help.

Accessory equipment connected to the any port of the Airvo 3 must be certified to IEC 60601-1 or IEC 60950-1. All configurations shall comply with the system standard IEC 60601-1-1. Anyone who connects additional equipment to the signal input part or signal output part configures a medical system and is therefore responsible for ensuring that the system complies with the requirements of the system standard IEC 60601-1-1. If in doubt, consult your technical services department or your local Fisher & Paykel Healthcare representative.

Certain elements of the software included with product are supplied under the license terms of third parties, including elements of the software that are subject to certain open source software licenses. Where required by the terms of these licenses, Fisher & Paykel Healthcare Limited provides notices regarding such software elements on its website. Please visit www.fphcare.com/airvo3/third-party-licenses to view these notices. Note that the notices that apply may be updated as the software included in the product is updated.

The F&P Airvo 3 is in compliance with Directive 2014/53/EU. The full text of the EU declaration of conformity is available at the following internet address: www.fphcare.com/certifications.

Device disposal instructions



This device contains electronics and a lithium battery. Please do not discard as regular waste. Return to Fisher & Paykel Healthcare or dispose according to local guidelines for disposing of electronics. In the European Union return to Fisher & Paykel Healthcare for disposal.



































Disposal of accessories, spare parts and packaging



Dispose of accessories, spare parts and packaging according to local guidelines. Place the breathing tube and water chamber in a waste bag at the end of use and discard with normal waste. Hospitals should discard according to their standard method for disposing of contaminated product.

Glossary

Symbols

 <p>For safety reasons, refer to the instructions for use</p>	 <p>Warning, hot surface</p>	 <p>Consult instructions for use for detailed information</p>	 <p>Warning: a potential hazard which, if not avoided, could result in death or serious injury</p>
 <p>Caution: a potential hazard which, if not avoided, could result in minor or moderate injury</p>	 <p>Note: emphasizes information important for using the Airvo 3 correctly</p>	 <p>Power on/off button</p>	 <p>System menu button</p>
 <p>Alarm limits</p>	 <p>Data and Graphs information button</p>	 <p>Pulse rate</p>	 <p>USB port and Compatible USB device detected</p>
 <p>Alarm symbol</p>	 <p>Class II equipment (double insulated)</p>	 <p>Do not discard as regular waste</p>	 <p>Discard as regular waste</p>
 <p>Temperature range</p>	 <p>Humidity range</p>	 <p>Do not use if package is damaged</p>	 <p>Type BF applied part (body floating)</p>
 <p>Touch lock enabled</p>	<p>IP22</p> <p>Protected against ingress of small objects and water drops</p>	 <p>Operating conditions</p>	 <p>Storage and transport conditions</p>
 <p>YYYY-MM-DD Date of manufacturer</p>	 <p>Manufacturer</p>	 <p>Magnetic Resonance (MR) Unsafe</p>	 <p>Non-ionizing electromagnetic radiation</p>
 <p>YYYY-MM-DD Date of manufacturer</p>	 <p>Serial number</p>	 <p>Catalogue number</p>	 <p>Batch code</p>
 <p>EU representative</p>	 <p>Medical Device</p>	<p>CE 0123</p> <p>Conforms with medical device directive 93/42/EEC</p>	 <p>Regulatory compliance mark (RCM)</p>

Appendix 1. Patient consumables

The patient interfaces and accessories shown in the tables below are approved for use with the Airvo 3. Carefully read the user instructions, including all warnings and cautions, supplied with each device before use.

Contact your Fisher & Paykel representative for the latest information on patient interfaces available for the Airvo 3. All patient interfaces are Type BF applied parts.

Optiflow high flow therapy

Description	Part number	Size	Pack size
Optiflow+ nasal interface	OPT942	Small	20
	OPT944	Medium	20
	OPT946	Large	20
Optiflow+ Duet interface	OPT962	Small	20
	OPT964	Medium	20
	OPT966	Large	20
Optiflow 3S nasal interface	OPT1042	Small	20
	OPT1044	Medium	20
	OPT1046	Large	20
Optiflow Junior 2 nasal interface*	OJR414 (WJR112)	M	20 (20)
	OJR416 (WJR112)	L	20 (20)
	OJR418 (WJR112)	XL	20 (20)
Optiflow Junior 2+ nasal interface*	OJR520 (WJR114)	XXL	10 (10)
Optiflow Junior 2 WigglewiNG	WJR212	M, L, XL	20
	WJR214	XXL	10
Optiflow+ tracheostomy interface	OPT970	15 mm	20
Optiflow+ mask adapter interface**	OPT980	22 mm mask interface adapter	20
AirSpiral tube and chamber kit	900PT561	—	10
AirvoNeb tube and chamber kit	900PT562	—	10

* Wigglepads part numbers are shown in parentheses.

** The mask adapter interface is designed for vented masks only. Do not use sealed masks with Optiflow high flow therapy.

Appendix 2. Parts and accessories

Carefully read the user instructions, including all warnings and cautions, supplied with each part or accessory before use. Contact your Fisher & Paykel representative for the latest information on parts and accessories available for the Airvo 3.

Accessories

Description	Part number
Mobile pole stand	900PT421
Mobile pole stand handle	900PT445
Mobile pole stand clamp	900PT428
Oxygen-bottle holder	900PT427, 900PT427L
Storage basket	900PT426
HPO Dual-Input Manifold (DISS, NIST, SIS)	900PT460D, 900PT460N, 900PT460S
HPO adapter (DISS to NIST)	900PT462DN
Airvo 3 data port adapter	900PT473
Airvo 3 USB service cable	900PT474
Airvo 3 Suite Service Application	900PT475
Disinfection kit*	900PT600

*A disinfection kit is required when using the built-in disinfection mode to disinfect the outlet elbow. It is not required for hospitals using a washer-disinfector to clean and disinfect the outlet elbow.

Spare parts

Description	Part number
Cleaning sponge sticks	900PT602
Storage cover	900PT603
Outlet elbow	900PT930
Air Filter	900PT933
Battery module	900PT957L

Appendix 3. Pulse oximetry accessories

The pulse oximetry accessories listed below are compatible with the Airvo 3. Carefully read the user instructions, including all warnings and cautions, supplied with each device before use. Not all accessories are available in all markets, and some accessories may not be available from Fisher & Paykel Healthcare.

Nonin:

Part numbers of compatible Nonin pulse oximetry USB connector cables

Description	Nonin part number (cable length)
Xpod® 3012 LP with USB Connector	6703-001 (1m)

Part numbers of compatible Nonin pulse oximetry sensor cables and sensor consumables

Sensor description	Nonin part number (cable length) (other information)
8000SS reusable soft sensors, small	6837-000 (1m), 6837-300 (3m)
8000SM reusable soft sensors, medium	6836-000 (1m), 6836-300 (3m)
8000SL reusable soft sensors, large	6835-000 (1m), 6835-300 (3m)
8000AA adult reusable finger clip sensors	3278-001 (1m), 3278-006 (2m), 3278-003 (3m)
8000AP pediatric reusable finger clip sensors	2360-000 (1m), 2360-003 (3m)
8000Q2 ear clip sensor	6455-000 (1m)
8000R reflectance sensor	0487-000 (1m)
8000J adult semi-reusable Flex Sensor	0741-000 (1m), 2353-002 (3m) (includes x25 8000JFW FlexiWraps®)
8008J infant semi-reusable Flex Sensor	0740-000 (1m) (includes x25 8008JFW FlexiWraps)
8001J neonatal semi-reusable Flex Sensor	0739-000 (1m) (includes x25 8001JFW FlexiWraps)
6000CA adult cloth disposable sensors	7426-001 (1m) (24 pack)
6000CP pediatric cloth disposable sensors	7426-002 (1m) (24 pack)
6000CI infant cloth disposable sensors	7426-003 (1m) (24 pack)
6000CN neonatal cloth disposable sensors	7426-004 (1m) (24 pack)
7000A adult Flexi-Form III disposable sensors	7427-001 (1m) (24 pack)
7000P pediatric Flexi-Form III disposable sensors	7427-002 (1m) (24 pack)
7000I infant Flexi-Form III disposable sensors	7427-003 (1m) (24 pack)
7000N neonatal Flexi-Form III disposable sensors	7427-004 (1m) (24 pack)
8000JFW adult FlexiWraps	4097-000, (25 pack), for use with 8000J
8008JFW infant FlexiWraps	4774-000, (25 pack), for use with 8008J
8001JFW neonatal FlexiWraps	4777-000, (25 pack), for use with 8001J
8000H reflectance sensor holder pack	0616-000, (10 caps & 20 adhesive stickers) for use with 8000R
Sensor Clip for LP Xpod External Pulse Oximeter	7504-001

Nonin™, Xpod®, PureLight®, PureSAT®, FlexiWraps®, Flexi-Form® are trademarks of Nonin Medical Inc.

Appendix 4. Humidification behavior during battery operation

The Airvo 3 reduces the energy used to humidify breathing gases when not powered from a wall power supply, to conserve battery power. In all cases, the Airvo 3 continues supplying supplementary oxygen and breathing gases until the battery is depleted.

For Optiflow high flow therapy, active humidification of the breathing gases is reduced during battery operation. If the Critically Low Battery alarm is raised, active humidification is stopped to conserve battery power.

Connect the Airvo 3 to a wall power supply before the battery is empty to automatically resume normal therapy. If the Airvo 3 battery is depleted, the device stops supplying supplementary oxygen and breathing gases, powers down and produces the Power Out alarm. To resume therapy after the device has powered down, connect the Airvo 3 to a wall power supply.

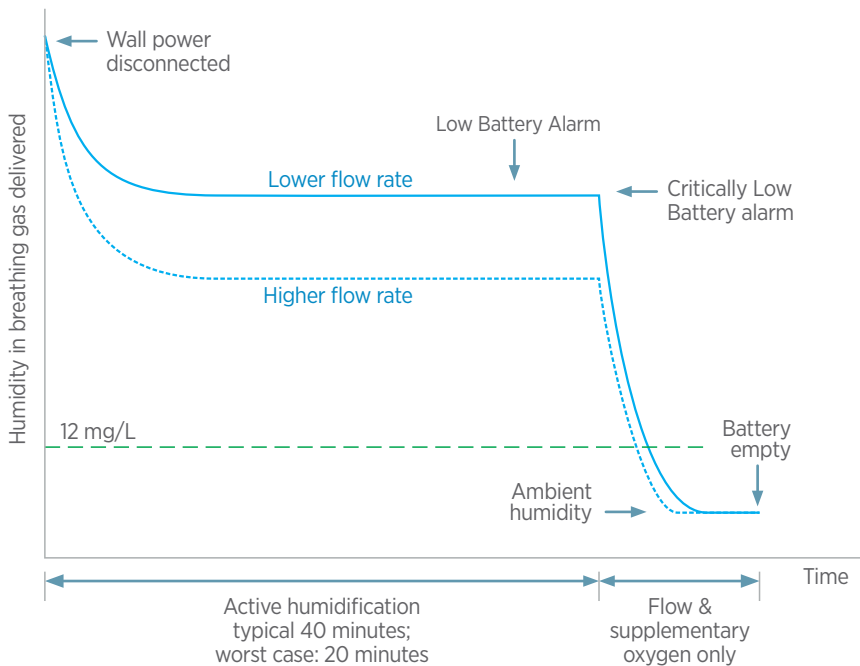

The Airvo 3 delivers reduced humidity in the breathing gas during Optiflow high flow therapy until the battery is nearly depleted, where humidity is turned off to maintain the delivery of flow and oxygen.

Manufacturer

Fisher & Paykel Healthcare Ltd,
15 Maurice Paykel Place,
East Tamaki, Auckland 2013

PO Box 14 348 Panmure,
Auckland 1741,
New Zealand

Tel: +64 9 574 0100
Fax: +64 9 574 0158
Email: info@fphcare.co.nz
Web: www.fphcare.com

Importer/ Distributor

Australia (Sponsor)

Fisher & Paykel Healthcare Pty Ltd,
19-31 King Street, Nunawading,
Melbourne, Victoria 3131.

Tel: +61 3 9871 4900
Fax: +61 3 9871 4998

Austria

Tel: 0800 29 31 23
Fax: 0800 29 31 22

Benelux

Tel: +31 40 216 3555
Fax: +31 40 216 3554

Brazil

Fisher & Paykel do Brasil,
Rua Sampaio Viana, 277 cj 21,
Paraíso, 04004-000,
São Paulo – SP, Brazil

Tel: +55 11 2548 7002

China

代理人/售后服务机构:

费雪派克医疗保健 (广州) 有限公司,
广州高新技术产业开发区科学城科丰
路31号G12栋301号

电话: +86 20 32053486
传真: +86 20 32052132

Denmark

Tel: +45 70 26 37 70
Fax: +46 83 66 310

Finland

Tel: +358 9 251 66 123
Fax: +46 83 66 310

France 

Fisher & Paykel Healthcare SAS,
10 Av. du Québec, Bât F5, BP 512,
Villebon-sur-Yvette, 91946
Courtaboeuf Cedex, France

Tel: +33 1 6446 5201
Fax: +33 1 6446 5221
Email: c.s@fphcare.fr

Germany

Fisher & Paykel Healthcare GmbH & Co. KG, Deutschland,
Österreich, Schweiz,
Wiesenstrasse 49,
D 73614 Schorndorf, Germany

Tel: +49 7181 98599 0
Fax: +49 7181 98599 66

Hong Kong

Tel: +852 2116 0032
Fax: +852 2116 0085

India

Tel: +91 80 2309 6400

Ireland

Tel: 1800 409 011
Fax: +44 1628 626 146

Italy

Tel: +39 06 7839 2939
Fax: +39 06 7814 7709

Japan

Tel: +81 3 5117 7110
Fax: +81 3 5117 7115

Korea

Tel: +82 2 6205 6900
Fax: +82 2 6309 6901

Norway

Tel: +47 21 60 13 53
Fax: +47 22 99 60 10

Russia

Tel. and Fax: +7 495 782 21 50

Spain

Tel: +34 902 013 346
Fax: +34 902 013 379

Sweden

Tel: +46 8 564 76 680
Fax: +46 8 36 63 10

Switzerland

Tel: 0800 83 47 63
Fax: 0800 83 47 54

Taiwan

Tel: +886 2 8751 1739
Fax: +886 2 8751 5625

Turkey

İthalatçı Firma: Fisher Paykel Sağlık
Ürünleri Ticaret Limited Şirketi,
İletişim Bilgileri: Ostim
Mahallesi 1249,
Cadde No:6, Yenimahalle
Ankara, Türkiye 06374

Tel: +90 312 354 34 12
Fax: +90 312 354 31 01

UK

Fisher & Paykel Healthcare Ltd,
Unit 16, Cordwallis Park, Clivemont Road, Maidenhead,
Berkshire SL6 7BU, UK

Tel: 0800 132 189
Fax: +44 1628 626 146

USA/Canada

Tel: 1800 446 3908
or +1 949 453 4000
Fax: +1 949 453 4001

For more information, please contact your
local Fisher & Paykel Healthcare representative.

CE 0123